

# Amphenol Filter Connectors

**Signal Integrity  
is our Business!**

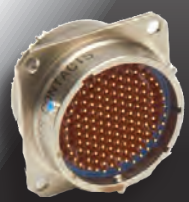
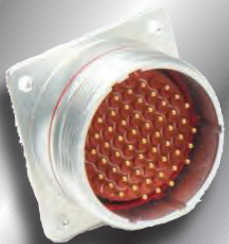
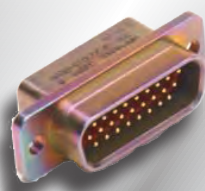

**Amphenol Canada Corp**  
[www.amphenolcanada.com](http://www.amphenolcanada.com)

## About Us

Headquartered in Toronto Canada and with subsidiaries in Belleville Canada and Nogales Mexico, Amphenol Canada Corp (ACC), a division of Amphenol Corporation has been an international leader in the interconnect industry. From design and manufacturing through quality inspection and shipping, Amphenol Canada has over 50 years of experience in the Military/Aerospace and Commercial markets.

Amphenol Canada (ACC) has pioneered many unique technologies to address the interconnect needs of increasingly demanding applications, including Filtered Connectors and Interconnect devices for EMI and EMP protection, Ruggedized connectors for Harsh Environments, industry-leading High Speed signal connectors for use in the rapidly growing In-flight Entertainment industry of Commercial Aviation.

With markets including Military and Commercial Aerospace and Defense, our expertise in understanding and supporting our many customers' interconnect needs has earned Amphenol Canada a reputation of quality and excellence among the world's leading users of electronic components.

## Mission Statement

In order to optimize our performance, we at Amphenol Canada (ACC) are committed to the following:

\* TO OUR CUSTOMERS  
we will provide service and quality products on time at the lowest cost, engineered with maximum innovation.

\* TO OUR EMPLOYEES  
we will provide a safe environment in which to work, opportunities for training and advancement and equitable compensation for their efforts.

\* TO OUR SUPPLIERS we will provide opportunities to participate in our business successes and will work with them on our goal of continuous improvement.



# Table of Contents

<b>Vertical Integration</b>	<b>3</b>
<b>Filter Connector Technical Data</b>	<b>4-6</b>
<b>Electrical Characteristics</b>	<b>7</b>
<b>Quality and Testing Capabilities</b>	<b>8</b>
<b>Capacitor Technology</b>	<b>9-10</b>
<b>Diode Technology</b>	<b>11-12</b>
<b>ARINC 600 Filter Connectors</b>	<b>13-18</b>
<b>ARINC 404 Filter Connectors</b>	<b>19-24</b>
<b>MIL-DTL-83527 Filter Connectors</b>	<b>25-28</b>
<b>D24308 D-Subminiature Filter Connectors</b>	<b>29-34</b>
<b>FD 308 Filter Connectors</b>	<b>35</b>
<b>M83513 Micro D-Sub Filter Connectors</b>	<b>36-42</b>
<b>MIL-DTL-38999 Filter Connectors</b>	<b>43-56</b>
<b>MIL-DTL-26482 Filter Connectors</b>	<b>57-61</b>
<b>M55116 Filter Audio Connectors</b>	<b>62-63</b>
<b>Termination Modules</b>	<b>64</b>
<b>FX Filter Plates</b>	<b>65-67</b>
<b>Quadrax Connectors and Contacts</b>	<b>68-70</b>
<b>Index of Products</b>	<b>71</b>

# Amphenol Canada

FILTERED AND RECTANGULAR CONNECTORS

Telephone: (416) 291-4401 Fax: (416) 292-0647 [www.amphenolcanada.com](http://www.amphenolcanada.com)



# Vertical Integration

Amphenol Canada's (ACC) facility is vertically integrated with the most up to date manufacturing and test capabilities. ACC can take your requirements for a high quality interconnect solution from initial concept through design, manufacturing and testing to deliver to your unique specification.

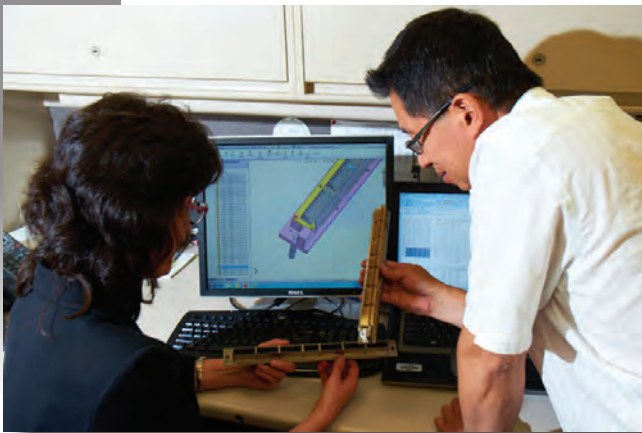

Engineering



Assembly



Machine Shop



Capacitor Manufacturing

# Filter Connector Technical Data

## Advantages of Filter Connectors

The integration of the filter elements into the connector, rather than a board level solution, results in many advantages to the user:

- reduction in space and weight
- reduction in inspection and assembly labour
- improved high frequency EMI performance by elimination of parasitic effects associated with board level filters
- superior shielding effectiveness

## Filter Connector Design

Filter connectors have been used for over thirty years to provide cost and space effective solutions to EMI problems in a wide range of military and commercial applications including avionics systems, satellites, missiles, communications, control systems and tempest equipment. A low pass filter connector incorporates capacitors and ferrite inductors into the connector body. The two capacitor types commonly used in filter connectors for military or avionics applications are planar arrays and tubular capacitors. Each of these capacitor types is an efficient filter at high frequencies (> 1 GHz) and has been proven to be extremely reliable when suitably assembled into a connector. Both planar and tubular designs feature Amphenol's unique solderless construction which reduces stress on the ceramic elements and results in superior physical and thermal shock capabilities.

### Planar Array

Amphenol Canada's planar design consists of planar ceramic capacitor arrays and discrete ferrite inductors assembled concentrically over the contacts and into the connector shell. The planars are compressed between rubber gaskets and have contact springs in each position which form a stress isolated connection with the contact body. The planars are grounded to the shell via a ground spring.

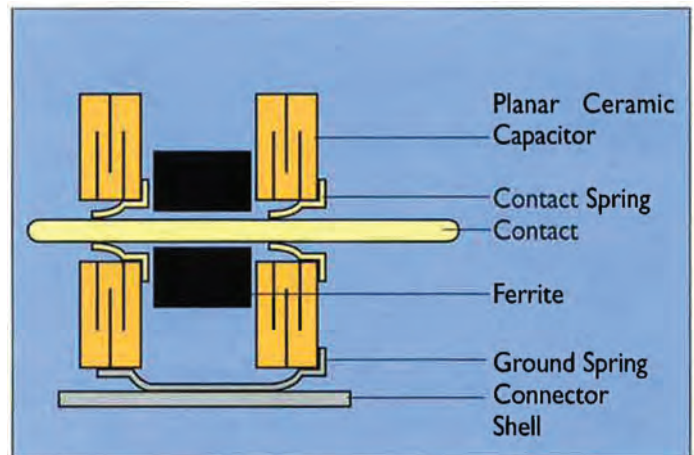

### Tubular Capacitor

Amphenol Canada's tubular design consists of a ferrite bead and ceramic tubular capacitor assembled onto a machined contact. The filter tube is connected to the contact with conductive rubber washers to provide a stress-isolated contact assembly. Grounding is achieved via a ground plate. These are typically used when the filter elements within the connection require more than a single dielectric material i.e. NPO and X7R.

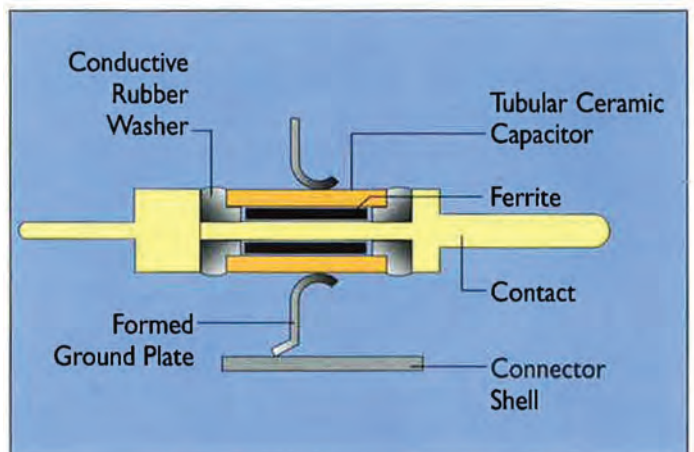





# Filter Connector Technical Data

## Filter Connector Selection

Selection of a particular filter circuit will depend on the required insertion loss characteristics and the system source and load impedances. By arranging the capacitive and inductive elements in a variety of combinations a number of equivalent circuits may be attained. The ferrite elements always face the low impedance side of the filter. These filter types are available in a wide range of capacitance and voltage values and may be selected in virtually any combination within the connector insert. In addition to filter contacts, insulated contacts, ground contacts and sealing plugs are available.

The following factors may affect the filter performance, and should be considered when selecting a filter connector and Amphenol Canada takes these into account when designing your filter solution.

Filter Circuit	Best Filtering Application
<b>PI</b> 	<b>Unknown or medium source and load impedance</b>
<b>LRC</b> 	<b>Low source and high load impedance</b>
<b>CLR</b> 	<b>High source and low load impedance</b>
<b>C</b> 	<b>High source and high load impedance</b>
<b>T</b> 	<b>Low source and low load impedance</b>

High source or load impedance >100ohms

Low source or load impedance <10ohms

### Operating Voltage

As a DC voltage is applied across a capacitor, the dielectric constant decreases, resulting in a capacitance decrease and a reduction in filter performance. The magnitude of the change is dependent upon the type of ceramic material used, the dielectric thickness and the magnitude of the voltage applied.

### Operating Currents

Operating currents cause magnetic saturation of inductive elements (ferrites). Therefore filters with ferrite inductors (Pi, CLR, LRC and T) will perform much like C filters as the ferrite approaches saturation. The saturation point can vary by ferrite characteristics and size but typically occurs above 0.1 mA.

### Operating Temperature Range

Capacitance and insertion loss performance are shown at 25°C. Depending on the type of ceramic material being used, capacitance can drop based on dielectric being used at temperature extremes. However, commonly used dielectrics have temperature coefficients of +/- 15% from -55°C to +125°C.

### Transient Voltage Requirements

Some transient voltage requirements may necessitate the addition of diodes or MOV's to the PCB or in the connector.



# Filter Connector Construction and Material Specifications

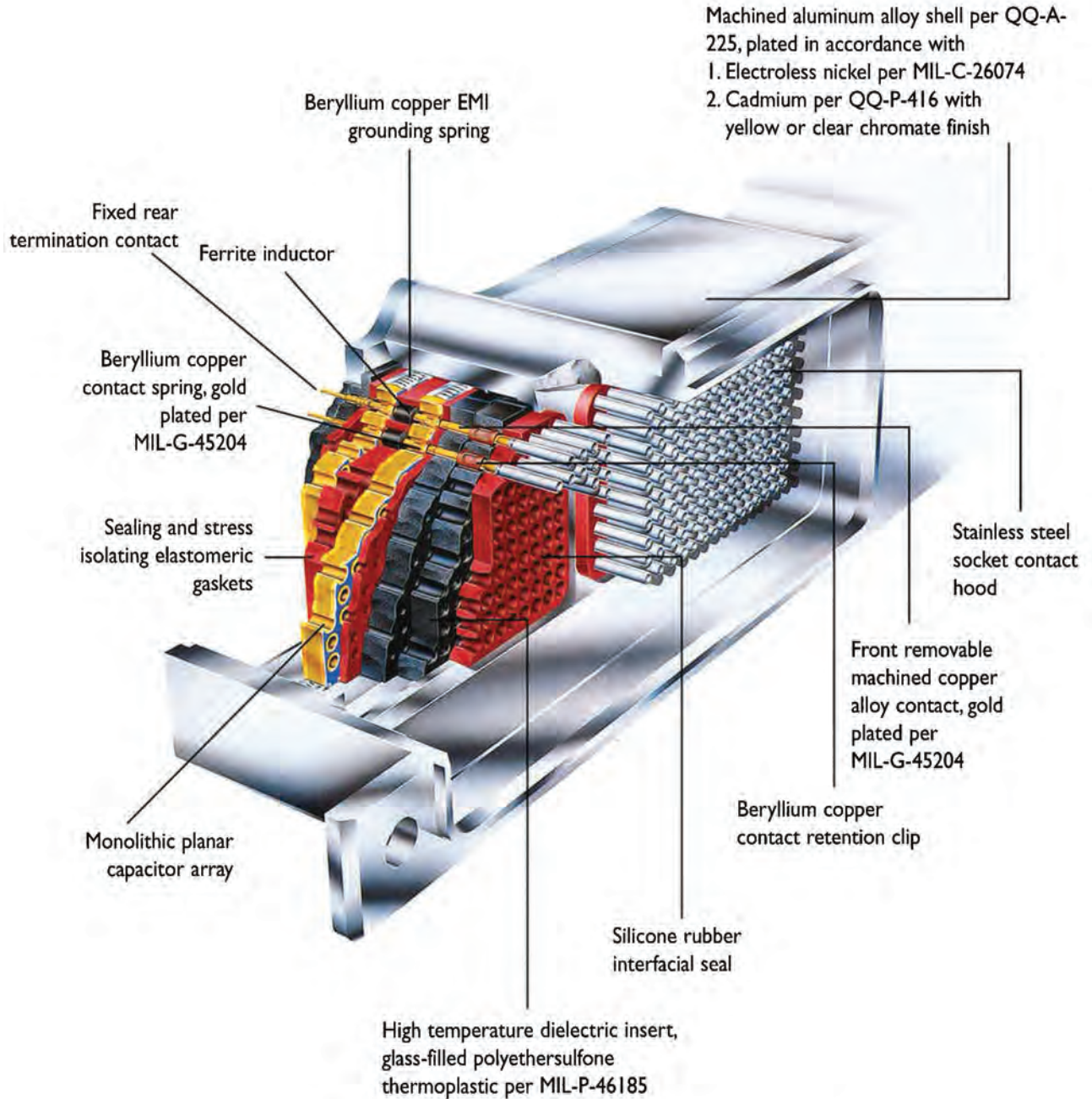

# Electrical Characteristics

Filter Circuit	PI				C, CLR, LRC, T					
Filter Type	PA4	P02	P04	P08	CA2	C01	C02	C04	C22	C50
Capacitance (pF) (@ 25°C, 1kHz & 1.0VRMS)	400 to 800	1800 to 3600	4000 to 8000	8000 to 16000	200 to 400	900 to 1800	1800 to 3600	4000 to 8000	22000 to 40000	50000 to 100000
Insertion Loss* (dB min.) (per MIL-STD-220 at 25°C & no load)	.1 MHz	-	-	-	-	-	-	-	-	3
	1 MHz	-	-	2	5	-	-	-	10	15
	10 MHz	2	10	15	18	-	4	8	13	26
	100 MHz	20	38	50	55	10	20	25	33	45
	1000 MHz	58	60	60	63	25	35	40	50	50
Working Voltage (VDC) (@ 25°C & sea level)	200								100	
Dielectric Withstanding Voltage (VDC) (@ 25°C & 50 mA max. charging current)	500								300	
Insulation Resistance (Gohms)(min) (@ 25°C & working voltage)	10									
Current Rating by Contact Size (continuous max., DC amperes)	#22 = 5 Amps #20 = 7.5 Amps					#16 = 13 Amps #12 = 23 Amps				
Filter RF Current Rating (amperes) (max. @ any frequency)	3									

Note: Other capacitance values, mixed capacitance arrangements, ground and insulated contacts are available.

Consult the factory for your particular application.

\* Acceptance testing performed to 500MHz maximum

## Typical Insertion Loss Performance (per MIL-STD-220)

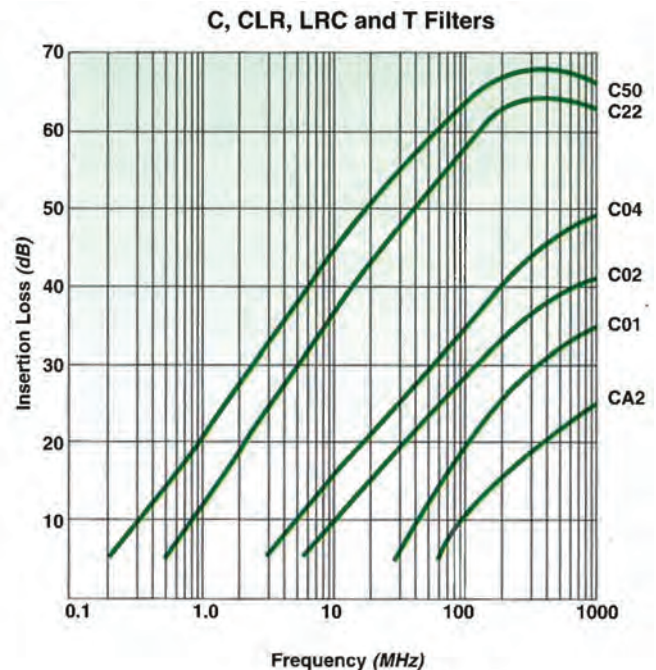
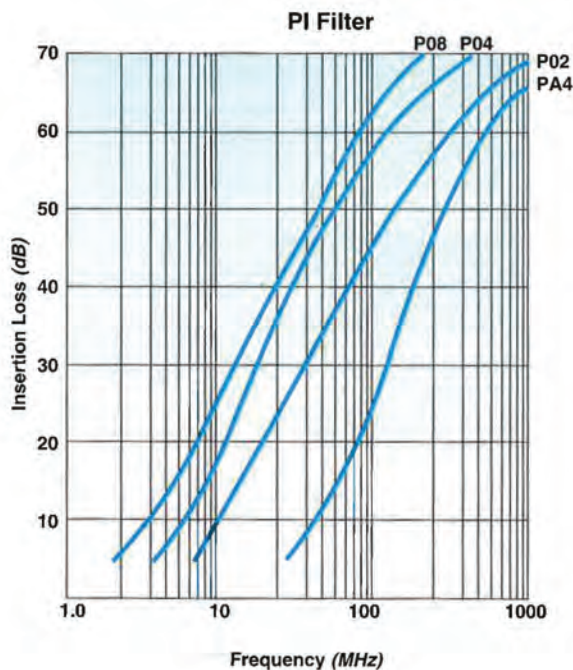



## Quality and Testing Capabilities

Amphenol Canada's (ACC) standard of quality is unsurpassed by anyone within the interconnect industry. We maintain focus on meeting and exceeding both our own and our customer's quality expectations. ACC's goal is to provide our customers with a quality Interconnect solution, on-time and at a reasonable price. The need for quality is a top down philosophy at ACC and is ingrained in all of our employees. Pride in workmanship along with maintaining growth is a key factor in ACC's success.

Certified to ISO 9001:2015 + AS9100:2016  
(certification available at [www.amphenolcanada.com](http://www.amphenolcanada.com))

### Test Capabilities

Insertion Loss

Capacitance, IR, DWV, Resistance

Eye Pattern and Differential TDR

Others including Qual testing



## Capacitor Technology

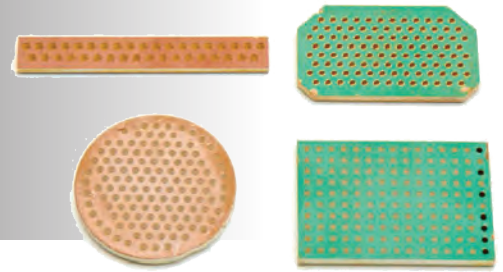

### Planar Array Capacitor

Filtering the interconnect I/O path has become the mainstay of meeting RTCA/DO-160 for high end military systems. The heart of that filtering is the placing of a capacitor network inside the connector. This allows for a complete solution for the LRU to meet both conducted and radiated emissions as required in most systems. In the late 1980's the development of the planar array capacitor allowed the user to be able to meet stringent attenuation requirements and also comply with the higher operating voltages that the signals were subjected to.

The planar array is a multi-layer multi-hole capacitor where each individual hole represents a capacitor that shares a common ground to the connector shell. The use of X7R ceramics allows ACC to manufacture a filter connector with capacitance from 100pF to 100nF within the same planar array in a 'C' circuit at operating voltages of 200VDC or higher up to 1000VDC.

There are very few limits to what can be achieved with the planar array. We can manufacture them with mixed capacitance, various hole diameters to suit the many insert arrangements of military connectors and the addition of insulated and ground lines. This allows our customers' designers to pick a filter connector from ACC that helps them comply with their systems' needs while being able to use a fewer number of I/O connectors making the overall box size smaller.

The planar is stacked by alternating ceramic with active electrodes to come up with the desired capacitance and the necessary working voltage. The electrodes are perpendicular to the contact so we can increase the thickness and thereby increase either capacitance or working voltage. The line to line dimensions in most insert arrangements dictate the electrical parameters but in the case of the planar array, this limitation is less of a factor.

ACC is one of the few filter connector companies that has an in-house capability to manufacture this key element in filter connector technology. This allows for the best in process control as well as being able to meet our customers short term needs for new designs.

# Capacitor Technology

## Tubular Capacitor

The need for a tubular capacitor in a filter connector is based on the need for programmability and extreme variations in capacitance. Some customers have needs that will require the filter connector to use more than one dielectric material. For instance, the need for some 60 pF lines and some 10,000 lines in the same connector. This can not be achieved with a planar array as the low capacitance lines require an NPO ceramic material and the 10,000 lines require an X7R material so we use tubular capacitors to achieve this.

The other instance is for programmability such as our 481 and 482 series of programmable filter connectors. The filter lines can be removed and new filter pins inserted to try different capacitance values to ensure that a box meets EMC requirements while in the test chamber.

The downside for tubular capacitors in a filter connector is that there are limitations on the capacitance versus voltage based on the density of the connectors insert arrangement. In tubular capacitors the electrodes run parallel to the contact and there is a need for an external ground plane. This means that the capacitance is highly limited to the pin to pin spacing and as such very high capacitance such as 50nF or higher are not possible with tubular capacitors in filter connectors.

The tubular capacitor is found mostly in commercial applications as the vibration and mechanical shock requirements are not as severe and so a more rugged component such as a planar array is not required.

## Chip Capacitor

ACC has the ability to use chip capacitor designs for filter connectors. This technology is not as prevalent in high end programs but can work well and where the insertion loss is required mostly at specific frequencies or where cost is a driver. This design is best for filter connectors with a 'C' circuit where the current eliminates the need for an in-line ferrite bead. In most cases the ferrite is not effective in filter circuits once current is supplied on the line, as the current increases past a few mA the ferrite bead saturates and the ferrite no longer contributes to the filter schematic making the Pi Network act like a C network.



# Transient Suppression Technology

## **Transient Suppression for Lightning and EMP Applications** *Designing for Lightning Induced Transient Susceptibility*

In addition to designing for control of steady state electromagnetic interference (EMI/EMC), modern avionics engineers must also design for the recent advent of much stricter requirements for immunity to lightning induced transient susceptibility. These requirements vary by equipment type and environmental area and are defined by a variety of military and commercial specifications including RTCA/DO-160 Section 22. The nature of the transient event ranges from very low level disturbances, requiring little or no protection, to high frequency and high energy events that can be disruptive or destructive to the avionics equipment. In general, practices which are good for control of EMI/EMC will also serve to mitigate the effects of lightning induced transients, but further measures must often be taken to ensure proper system operation and survivability. One of the more effective methods available is the inclusion of circuit protective devices in the circuit at the input of the LRU. The most common types of devices employed are Zener suppression diodes and metal oxide varistors (MOV's). These non-linear V-I devices conduct very little current at low voltage levels, but once above the breakdown voltage, the voltage across the device remains fairly constant.

## **Filter Connectors with Transient Suppressors**

While conventional EMI filter connectors have been shown to be effective in providing protection against low energy transients, they offer little protection from high voltage/high energy transients that may result from lightning, load switching, electrostatic discharge (ESD) or electromagnetic pulse (EMP). For those applications requiring protection of sensitive circuitry from such overvoltage events, Zener suppression diodes or MOV's can be incorporated into the connector body in combination with EMI filtering or alone. Combining the transient suppression device into the connector provides several advantages:

- saves space and weight versus placing discrete components onto a PCB
- reduces system design time
- reduces number of components
- improves voltage clamping performance by eliminating parasitic lead resistance and inductance of board level components
- allows for retrofit of existing equipment requiring lightning or EMP hardening
- improves system repairability and maintenance logistics

## Diode Technology

### **Amphenol Canada/Diode Protected Connectors**

#### *Custom Diode / Contact Assembly Design*

In this approach a custom diode/contact assembly is installed into an insert with a ground plate. This leaded assembly installed on each contact in the connector is ideal for environments requiring clamping of an extremely fast rise time transient. This design also allows for easy removal and replacement of the front socket contacts. In addition, each diode is individually replaceable at the factory in the event that repair is necessary.

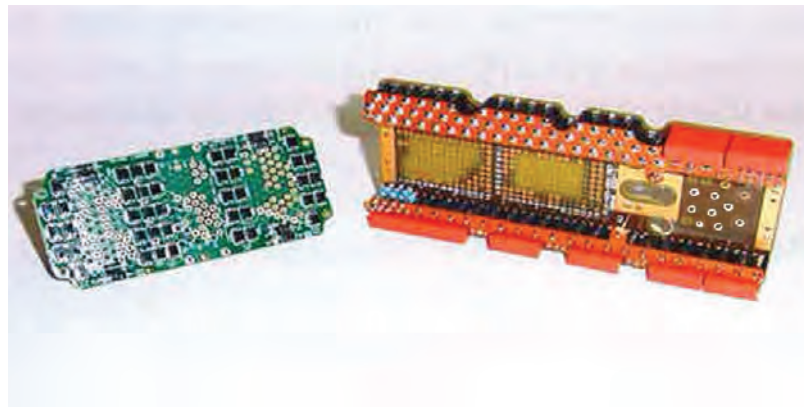

This approach incorporates diode protection by populating a printed circuit board with surface mount and/or thru hole mount components. The components can be zener diodes, varistors, inductors, etc and can be selected from commercially available parts. This cost effective design still allows for easy removal and replacement of front socket contacts as well as individual replacement and repair of mounted components at the factory.

# Amphenol Canada

## Filter Connectors

# Filter Rack and Panel Connectors

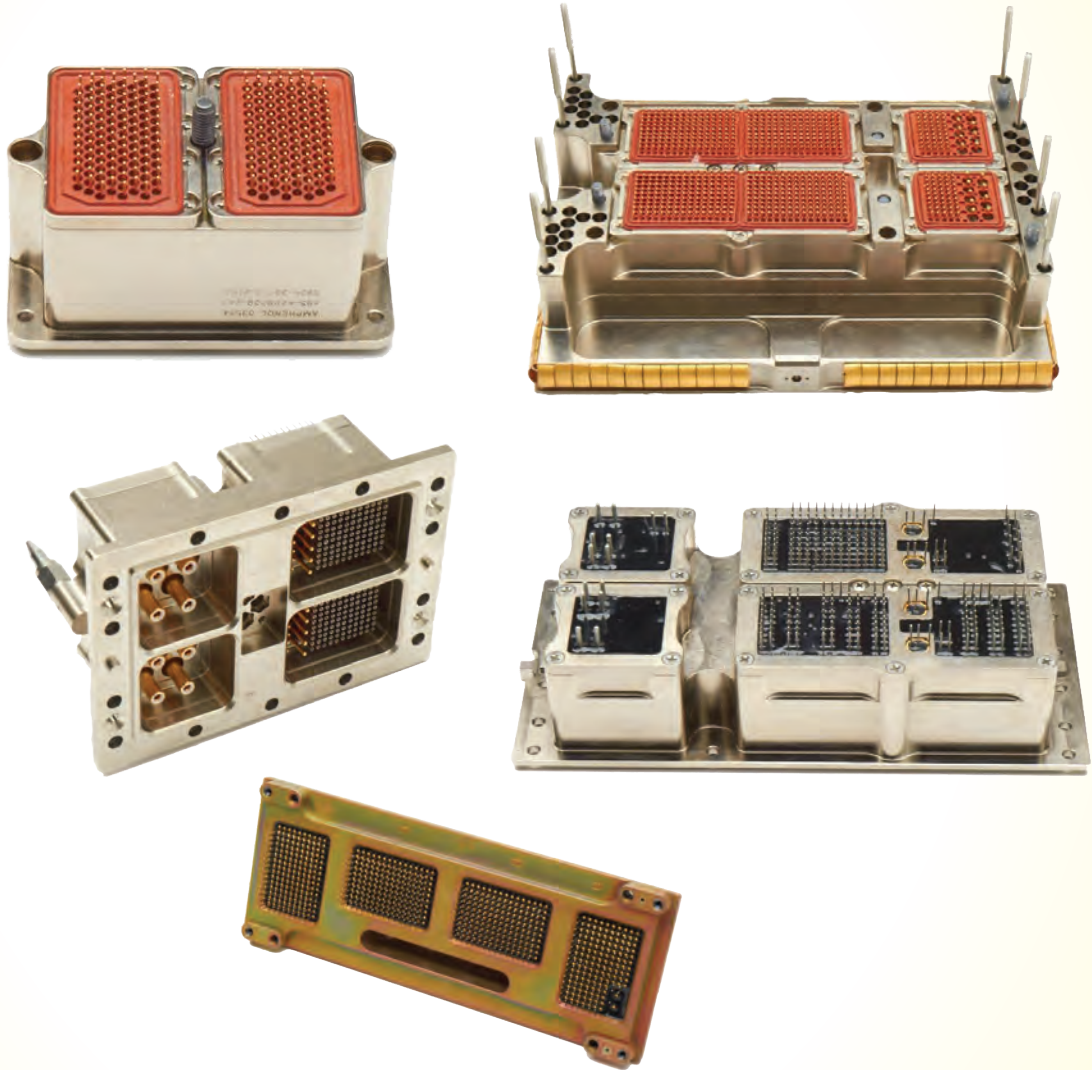

# Amphenol

FILTERED AND RECTANGULAR CONNECTORS

Telephone: (416) 291-4401 Fax: (416) 292-0647 [www.amphenolcanada.com](http://www.amphenolcanada.com)



# ARINC 600 Filter Connectors

ARINC 600 connectors are the recognized standard rack and panel interconnect system for use in commercial avionics. These connectors come in 3 sizes that can hold up to 800 individual contacts. Amphenol ACC is the world leader in the filtering of this series and has many capabilities to meet our customers varied requirements. This includes, but is not limited to, Pi, C, LC, T filters as well as the addition of transient suppression diodes to allow for the successful EMC test requirements of DO-160.

## Materials and Plating

Shell – Aluminum alloy  
 Polarizing Keys – Aluminum alloy electroless nickel  
 Insulators – Glass filled plastic  
 Seals – Silicone/fluorosilicone elastomer blend  
 Contacts – copper alloy gold plate

## Part Numbering System

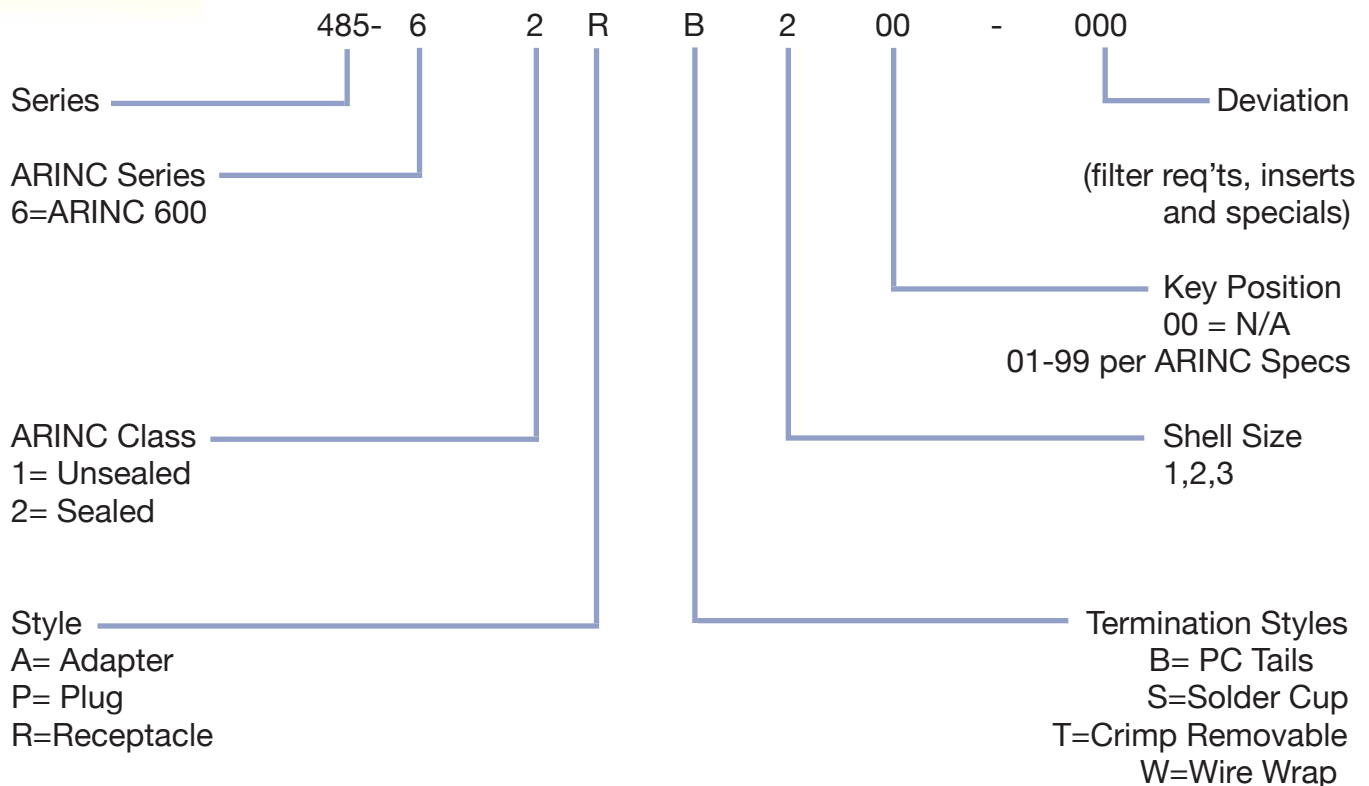

# ARINC 600 Style Filter Connectors

## Receptacle Shell Size 1

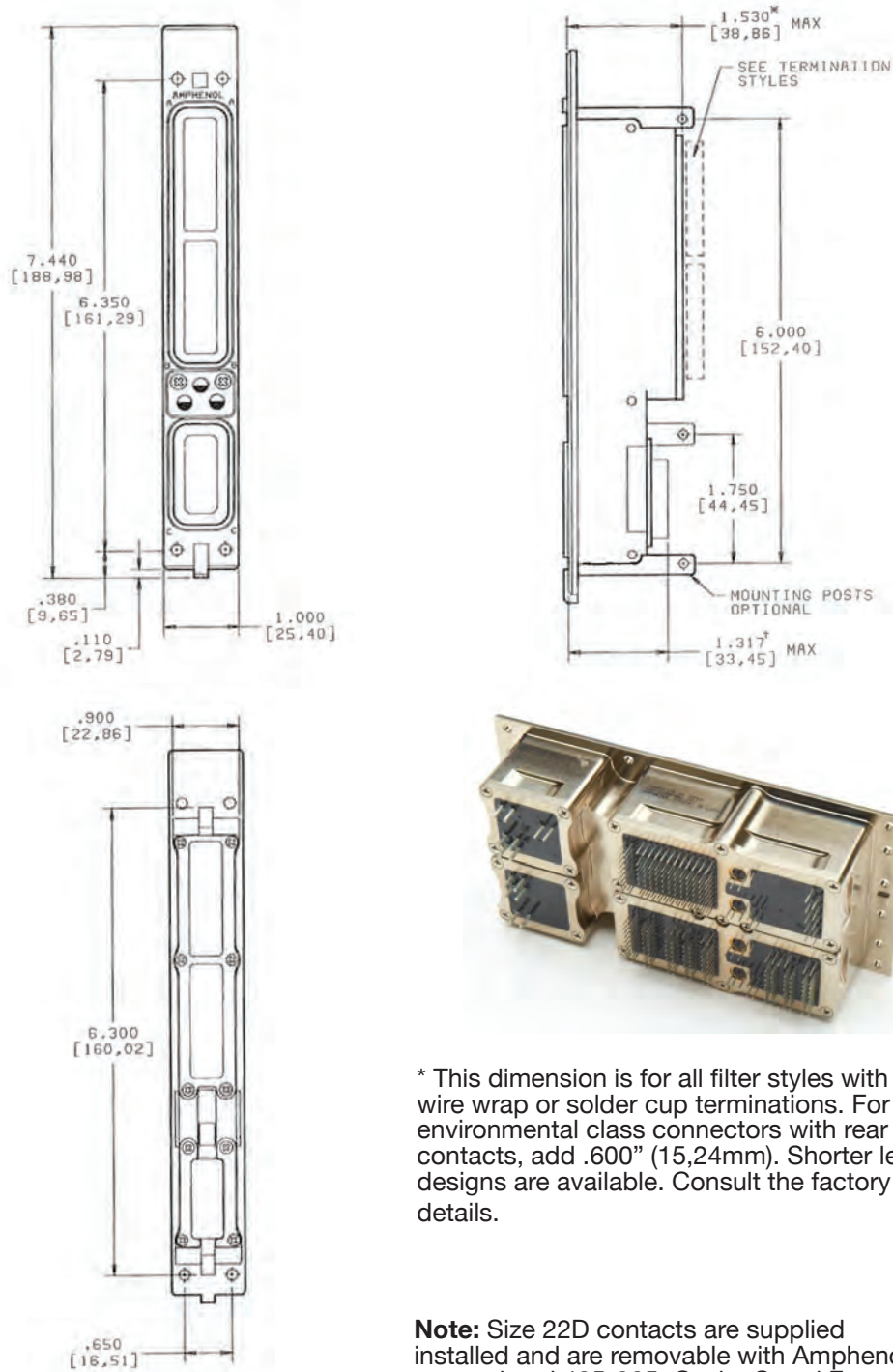

\*ARINC 600 Cavity C and F and MIL-DTL-C-83527 Cavity B and D dimensions are shown unfiltered.

\* This dimension is for all filter styles with PCB, wire wrap or solder cup terminations. For environmental class connectors with rear release contacts, add .600" (15,24mm). Shorter length designs are available. Consult the factory for details.

**Note:** Size 22D contacts are supplied installed and are removable with Amphenol insertion/removal tool 485-905. Cavity C and F power contacts are packaged separately. Coax and triax contacts may be ordered separately.

# ARINC 600 Style Filter Connectors

## Receptacle Shell Size 2

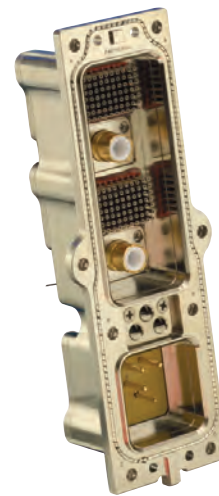
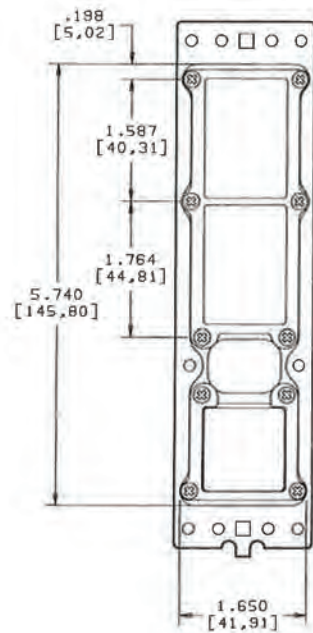
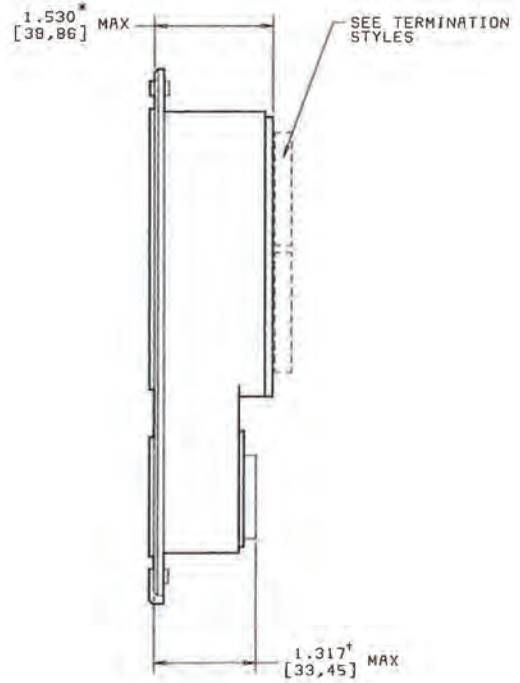
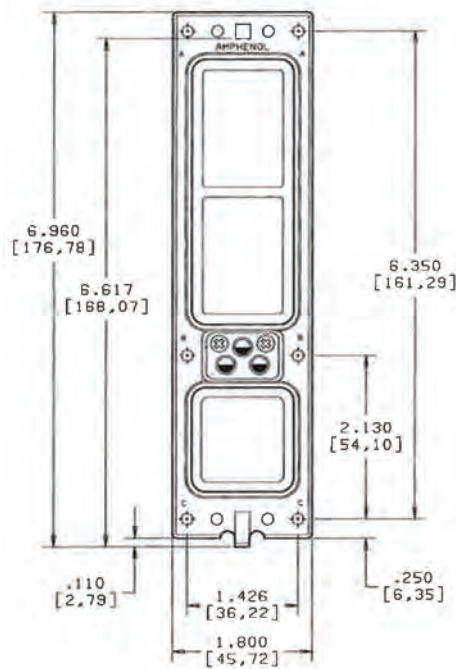

\*Cavity C dimension is shown unfiltered.

\* This dimension is for all filter styles with PCB, wire wrap or solder cup terminations. For environmental class connectors with rear release contacts, add .600" (15,24mm). Shorter length designs are available. Consult the factory for details.

**Note:** Size 22D contacts are supplied installed and are removable with Amphenol insertion/removal tool 485-905. Cavity C and F power contacts are packaged separately. Coax and triax contacts may be ordered separately.



# ARINC 600 Style Filter Connectors

## Receptacle Shell Size 3

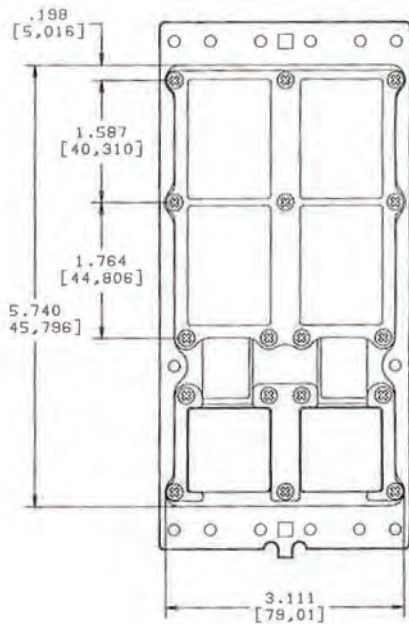
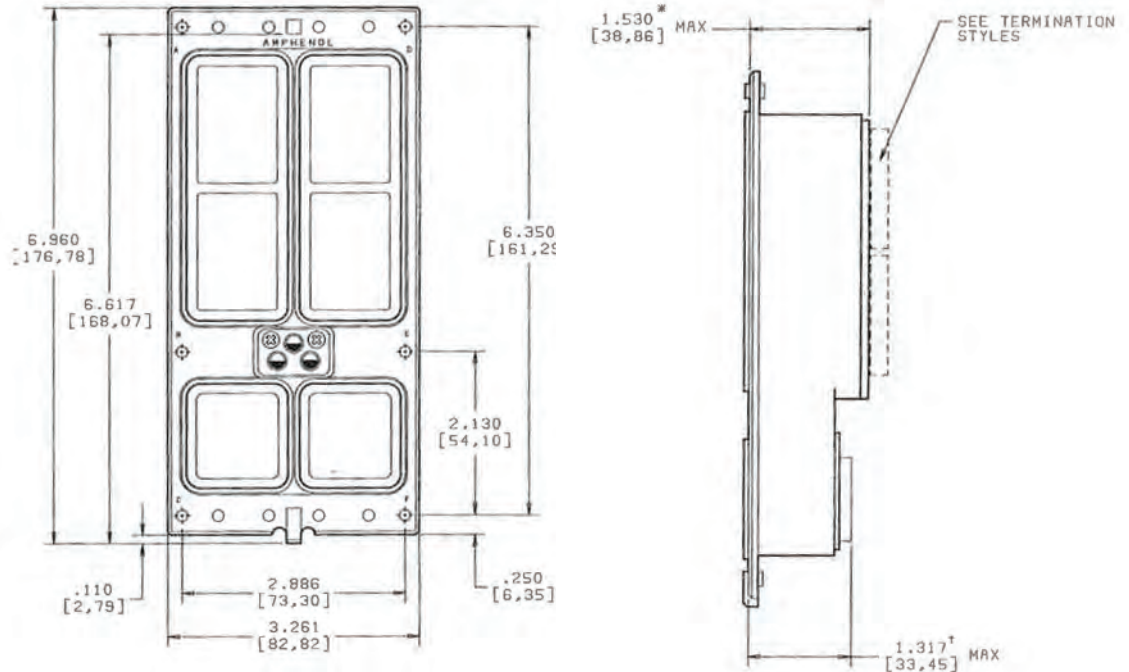

\*Cavity C dimension is shown unfiltered.



\* This dimension is for all filter styles with PCB, wire wrap or solder cup terminations. For environmental class connectors with rear release contacts, add .600" (15,24mm). Shorter length designs are available. Consult the factory for details.

**Note:** Size 22D contacts are supplied installed and are removable with Amphenol insertion/removal tool 485-905. Cavity C and F power contacts are packaged separately. Coax and triax contacts may be ordered separately.

# ARINC 600 Insert Arrangements

Shell Size 2 or 3, Cavity A, B, D or E

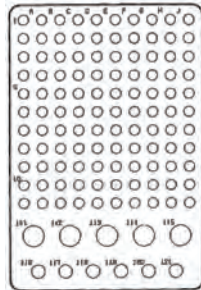

**Insert 121**  
110 #22 Contacts  
5 #16 Contacts  
6 #20 Contacts

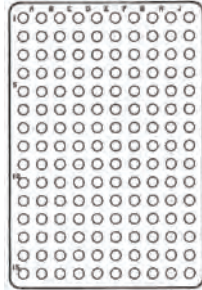

**Insert 150**  
150 #22 Contacts

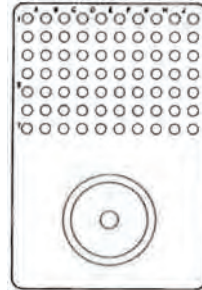

**Insert 71C1**  
70 #22 Contacts  
1 #1 Coax Contacts

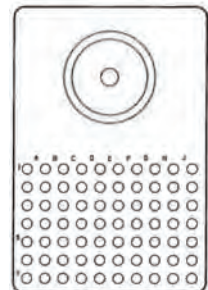

**Insert 71C1A**  
70 #22 Contacts  
1 #1 Coax Contacts

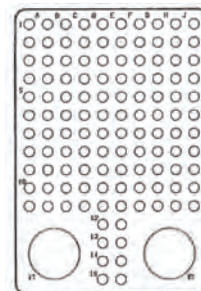

**Insert 120T2**  
118 #22 Contacts  
2 #8 Triax/Coax Contacts

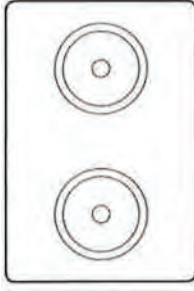

**Insert C2**  
2 #1 Coax Contacts

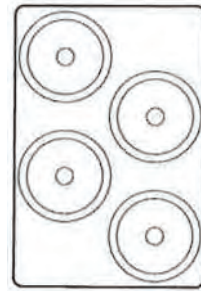

**Insert C4**  
4 #1 Coax Contacts

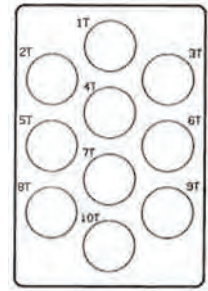

**Insert 10T10**  
10 #8 Triax/Coax Contacts

## Shell Size 2 or 3, Cavity C or F

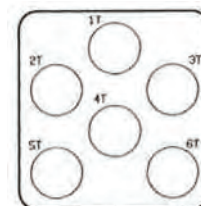

**Insert 6T6**  
6 #8 Triax/Coax Contacts

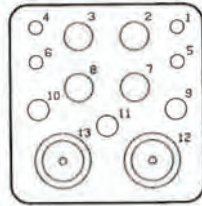

**Insert 13C2**  
4 #12 Contacts  
3 #16 Contacts  
4 #20 Contacts  
2 #5 Coax Contacts

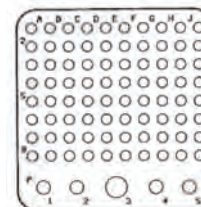

**Insert 85**  
80 #22 Contacts  
4 #20 Contacts  
1 #16 Contacts

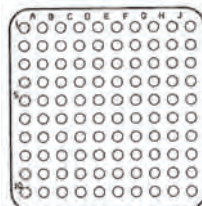

**Insert 100**  
100 #22 Contacts

## Shell Size 1

### Cavity A or B



**Insert 60**  
60 #22 Contacts

### Cavity C

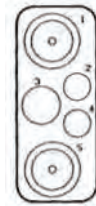

**Insert 5C2**  
1 #12 Contacts  
2 #16 Contacts  
2 #5 Coax Contacts

**Note:** Consult the factory for other insert patterns.

# ARINC 404 and MIL-DTL-81659 Filter Connectors

ARINC 404 connectors and the Military equivalent MIL-DTL-81659 are a long time standard in both military and commercial aviation LRU's. These connectors come in 4 sizes that can hold up to 424 individual contacts. Amphenol ACC is the world leader in the filtering of this series and has many capabilities to meet our customers varied requirements. This includes, but is not limited to, Pi, C, LC, T filters as well as the addition of transient suppression diodes to allow for the successful EMC test requirements of DO-160.

## Materials and Plating

Shell – Aluminum alloy  
 Polarizing Keys – Aluminum alloy electroless nickel  
 Insulators – Glass filled plastic  
 Seals – Silicone/fluorosilicone elastomer blend  
 Contacts – Copper alloy gold plate

## Part Numbering System

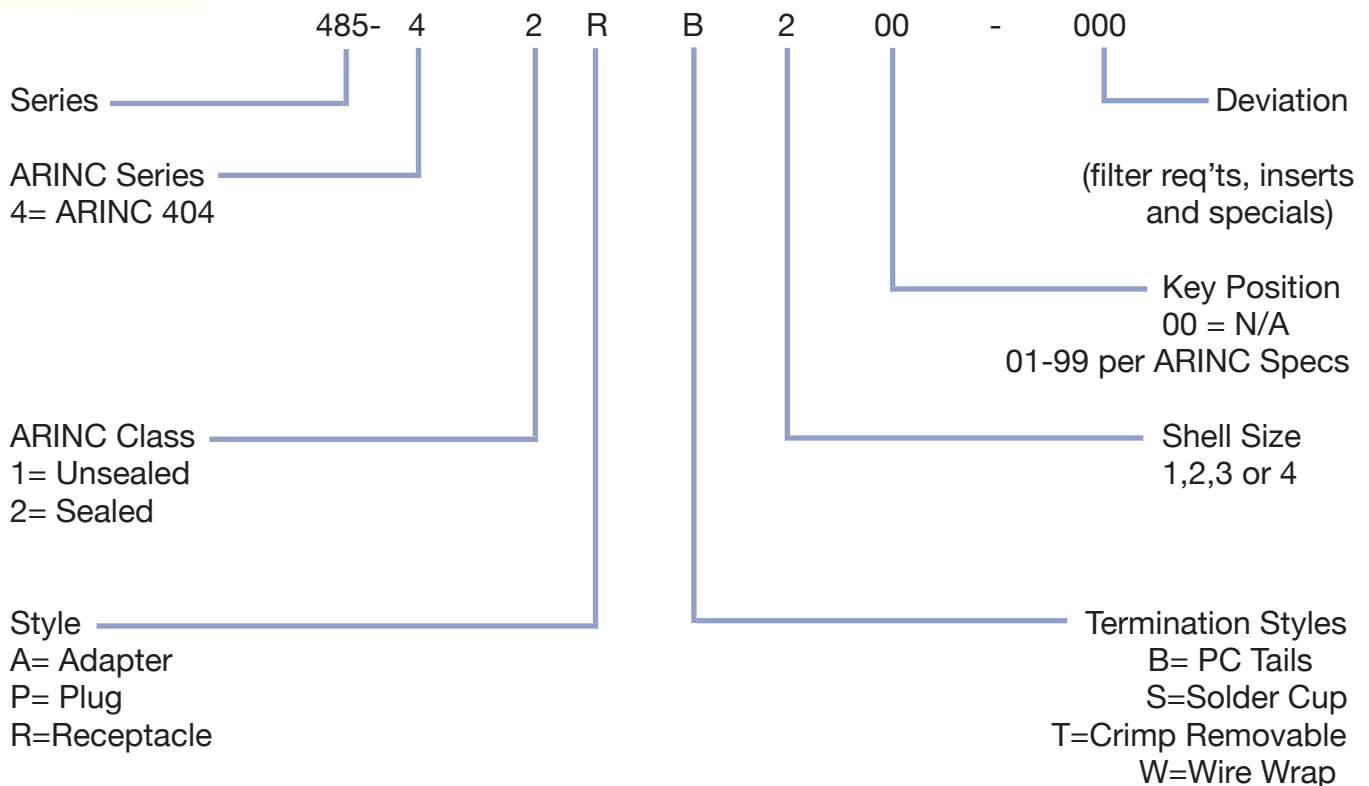



# ARINC 404 and MIL-DTL-81659 Filter Connectors

## Receptacle Shell Size 1

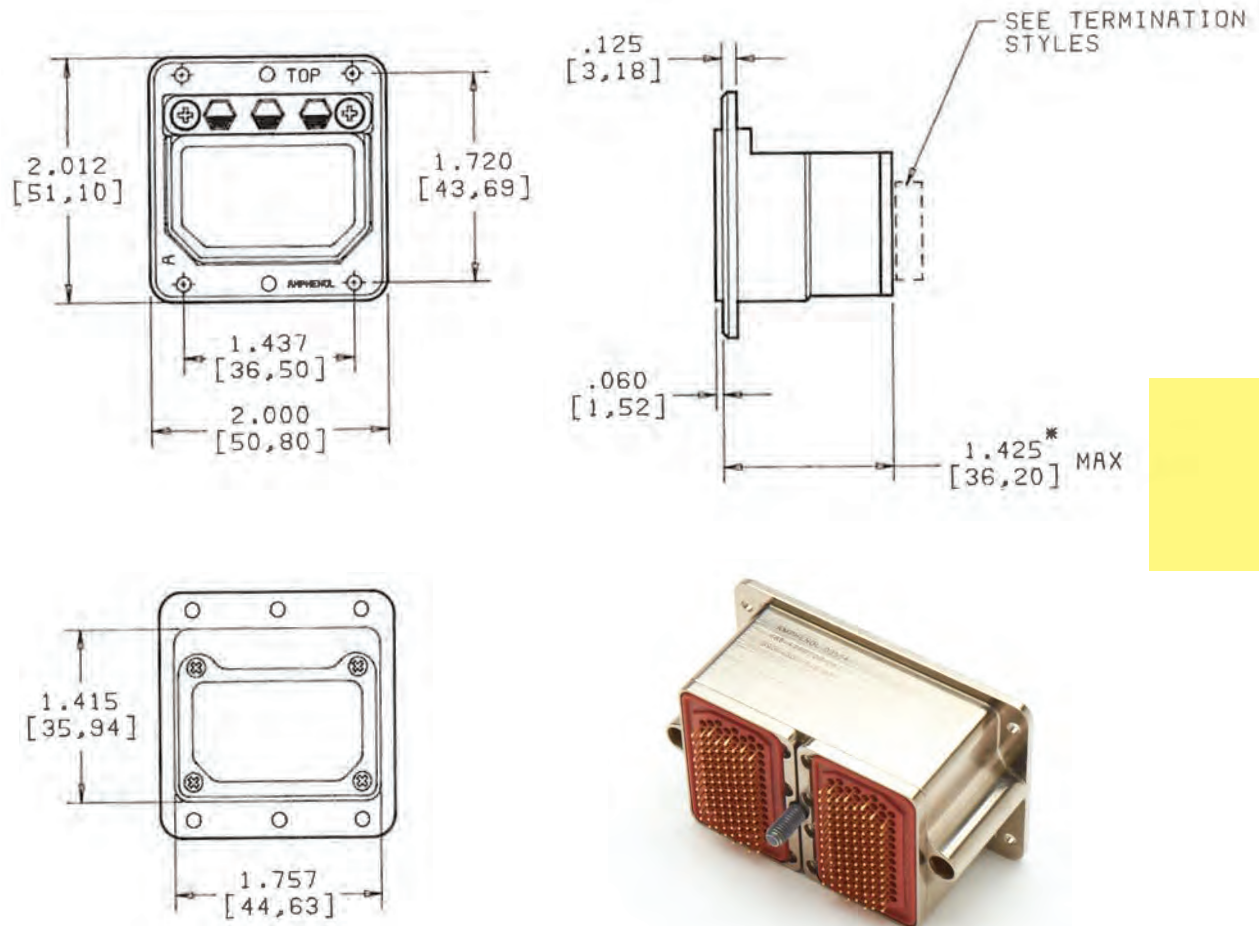

\* This dimension is for all filter styles with PCB, wire wrap or solder cup terminations. For environmental class connectors with rear release contacts, add .600" (15,24mm). Shorter length designs are available. Consult the factory for details.

**Note:** Size 22D contacts are supplied installed and are removable with Amphenol insertion/removal tool 485-905. Pin contacts are not removable. Coax and triax contacts may be ordered separately.

# ARINC 404 and MIL-DTL-81659 Filter Connectors

## Receptacle Shell Size 2

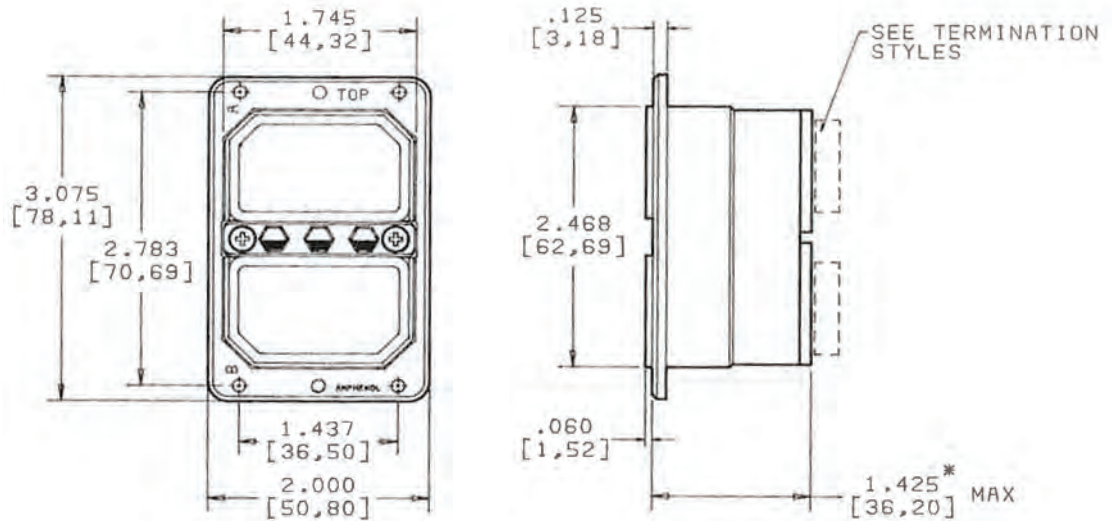

\* This dimension is for all filter styles with PCB, wire wrap or solder cup terminations. For environmental class connectors with rear release contacts, add .600" (15,24mm). Shorter length designs are available. Consult the factory for details.

**Note:** Size 22D contacts are supplied installed and are removable with Amphenol insertion/removal tool 485-905. Pin contacts are not removable. Coax and triax contacts may be ordered separately.

# ARINC 404 and MIL-DTL-81659 Filter Connectors

## Receptacle Shell Size 3

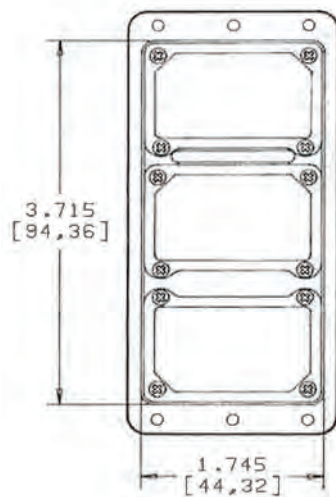
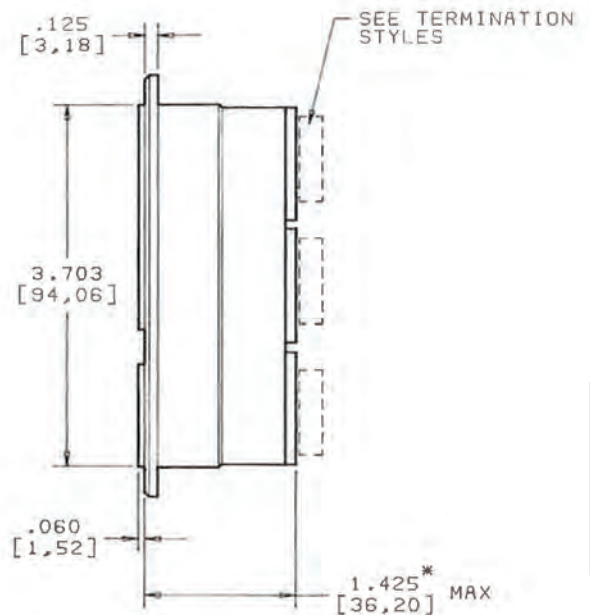
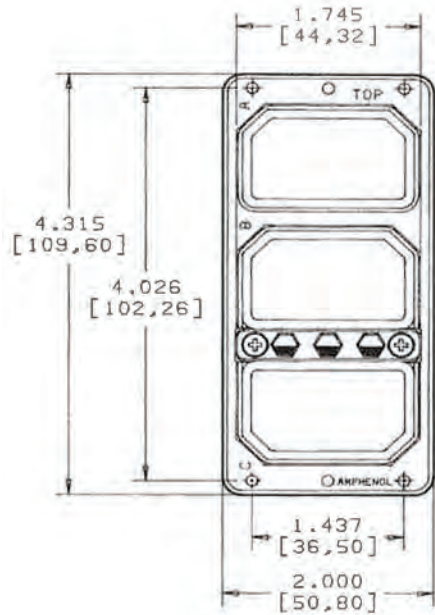

\* This dimension is for all filter styles with PCB, wire wrap or solder cup terminations. For environmental class connectors with rear release contacts, add .600" (15,24mm). Shorter length designs are available. Consult the factory for details.

**Note:** Size 22D contacts are supplied installed and are removable with Amphenol insertion/removal tool 485-905. Pin contacts are not removable. Coax and triax contacts may be ordered separately.



# ARINC 404 and MIL-DTL-81659 Filter Connectors

## Receptacle Shell Size 4

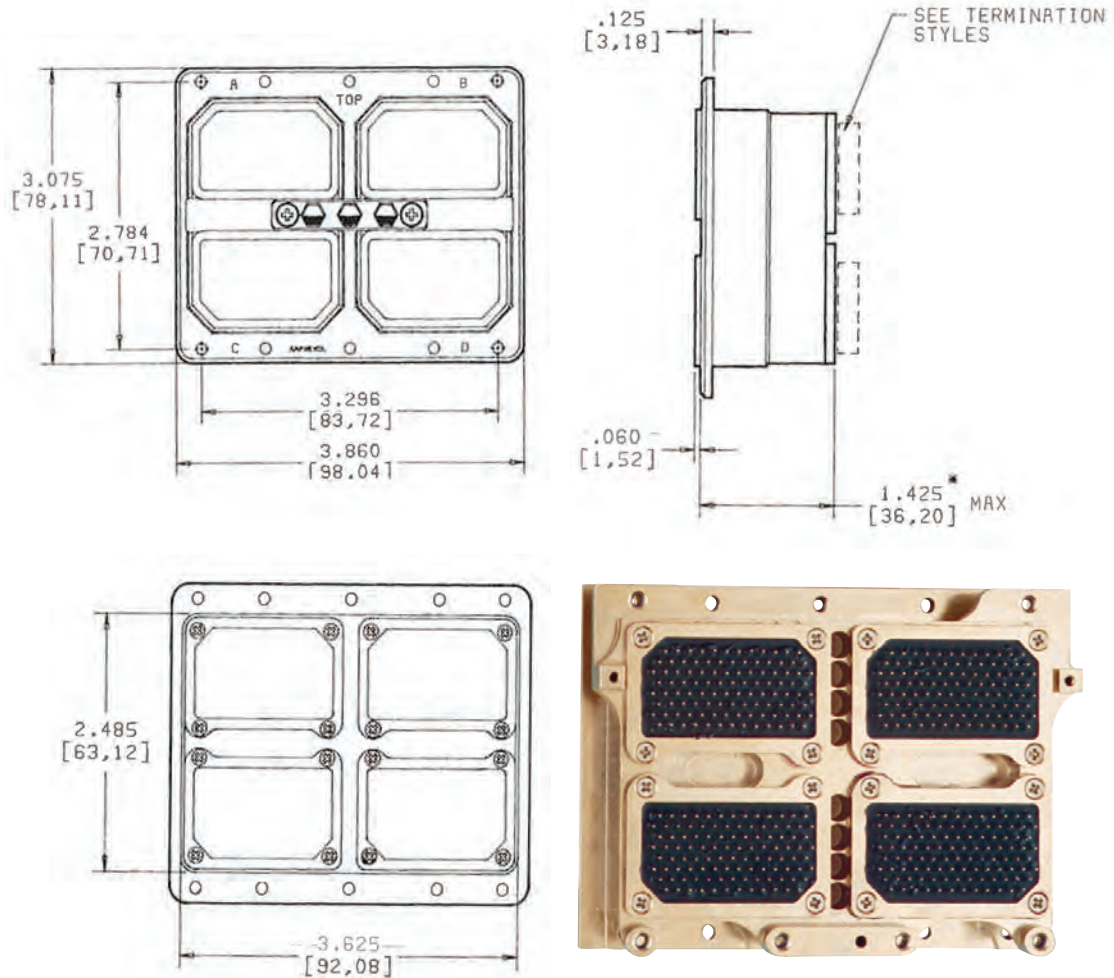

\* This dimension is for all filter styles with PCB, wire wrap or solder cup terminations. For environmental class connectors with rear release contacts, add .600" (15,24mm). Shorter length designs are available. Consult the factory for details.

**Note:** Size 22D contacts are supplied installed and are removable with Amphenol insertion/removal tool 485-905. Pin contacts are not removable. Coax and triax contacts may be ordered separately.

# ARINC 404 and MIL-DTL-81659 Insert Arrangements



**Insert 26**  
26 #16 Contacts

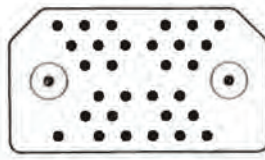

**Insert 32C2**  
30 #20 Contacts  
2 #5 Coax Contacts

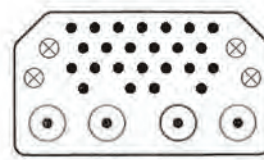

**Insert 32C4**  
24 #20 Contacts  
4 #16 Contacts  
4 #5 Coax Contacts

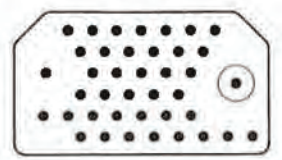

**Insert 40C1**  
39 #20 Contacts  
1 #5 Coax Contacts

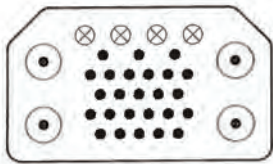

**Insert 33C4**  
25 #20 Contacts  
4 #16 Contacts  
4 #5 Coax Contacts

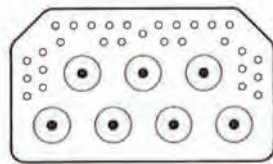

**Insert 36C7**  
29 #22 Contacts  
7 #5 Coax Contacts

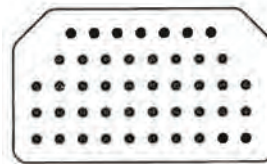

**Insert 45**  
45 #20 Contacts

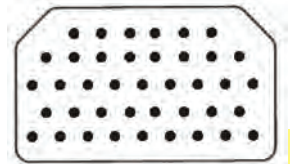

**Insert 40**  
40 #20 Contacts

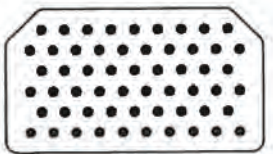

**Insert 57**  
57 #20 Contacts

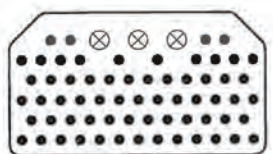

**Insert 67**  
64 #20 Contacts  
3 #16 Contacts

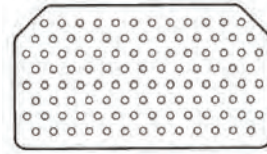

**Insert 106**  
106 #22 Contacts

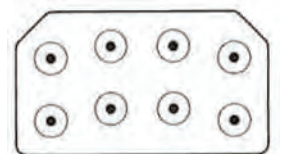

**Insert C8**  
8 #9 Coax Contacts

**Note:** Consult the factory for other insert patterns.

## ARINC 404 and 600 Termination Styles

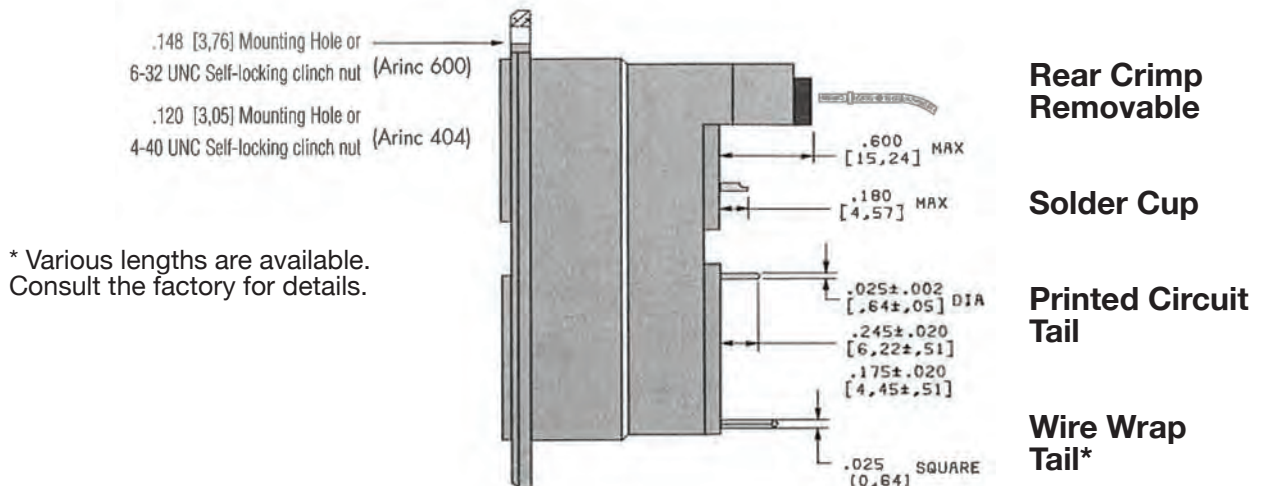

\* Various lengths are available. Consult the factory for details.

# MIL-DTL-83527 Filter Connectors

MIL-DTL-83527 is a rack and panel blind mate series designed for the rugged applications found mostly in military applications. Amphenol Canada's filtered MIL-DTL-83527 series is intermateable and interchangeable with all non-filtered versions of the same specification. This series has numerous insert arrangements to house signal, high speed RF, Twinax and quadrx ethernet lines and we can combine these with filter and EMP requirements to support our customers many applications.

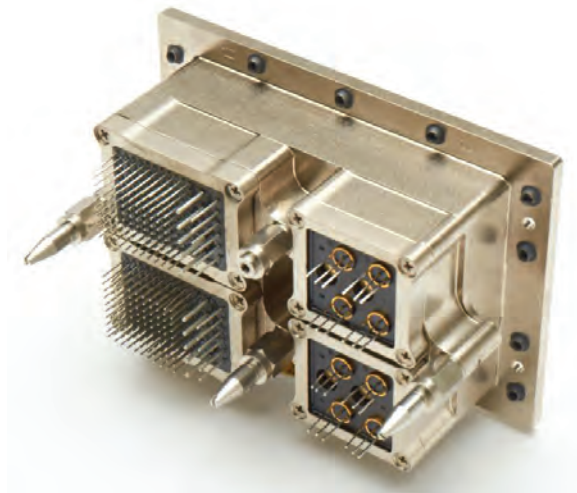
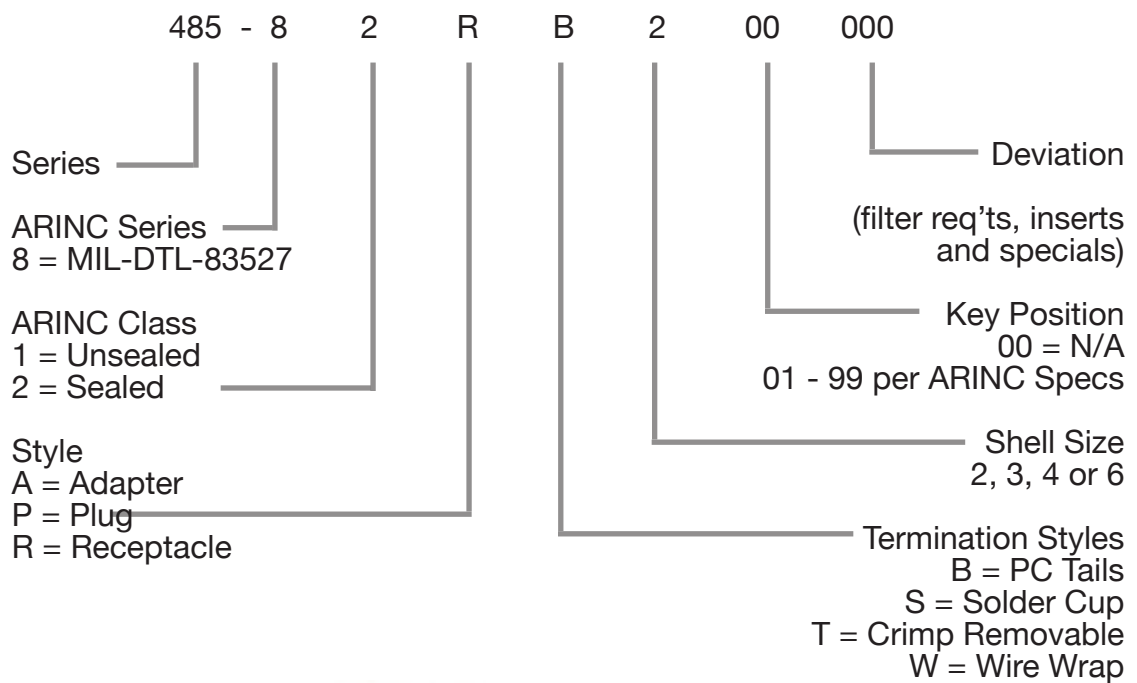



# MIL-DTL-83527 Filter Connectors

## Receptacle Shell Size 2

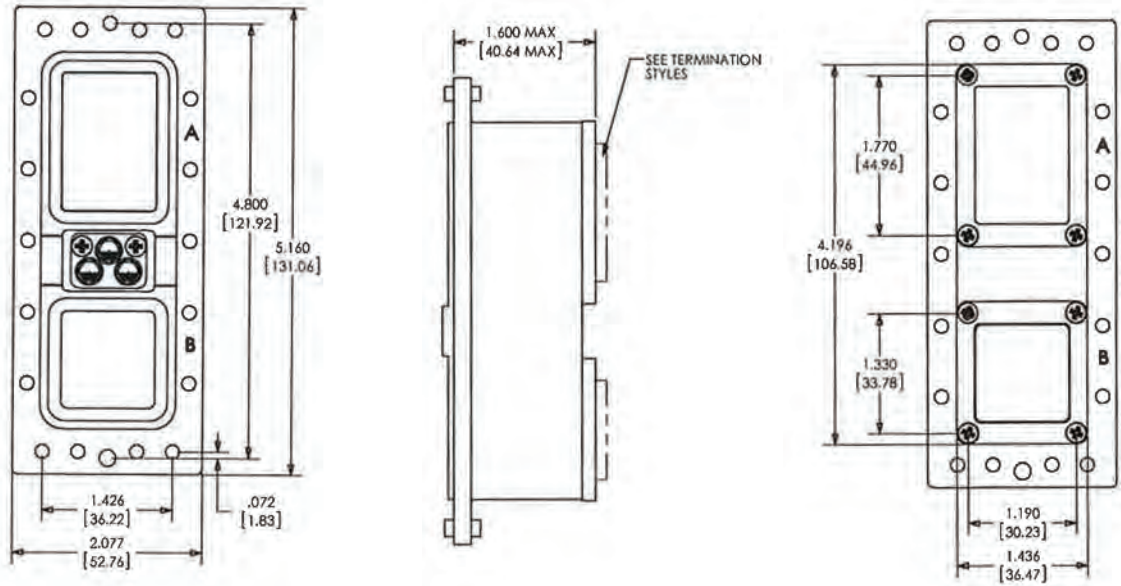

## Receptacle Shell Size 3

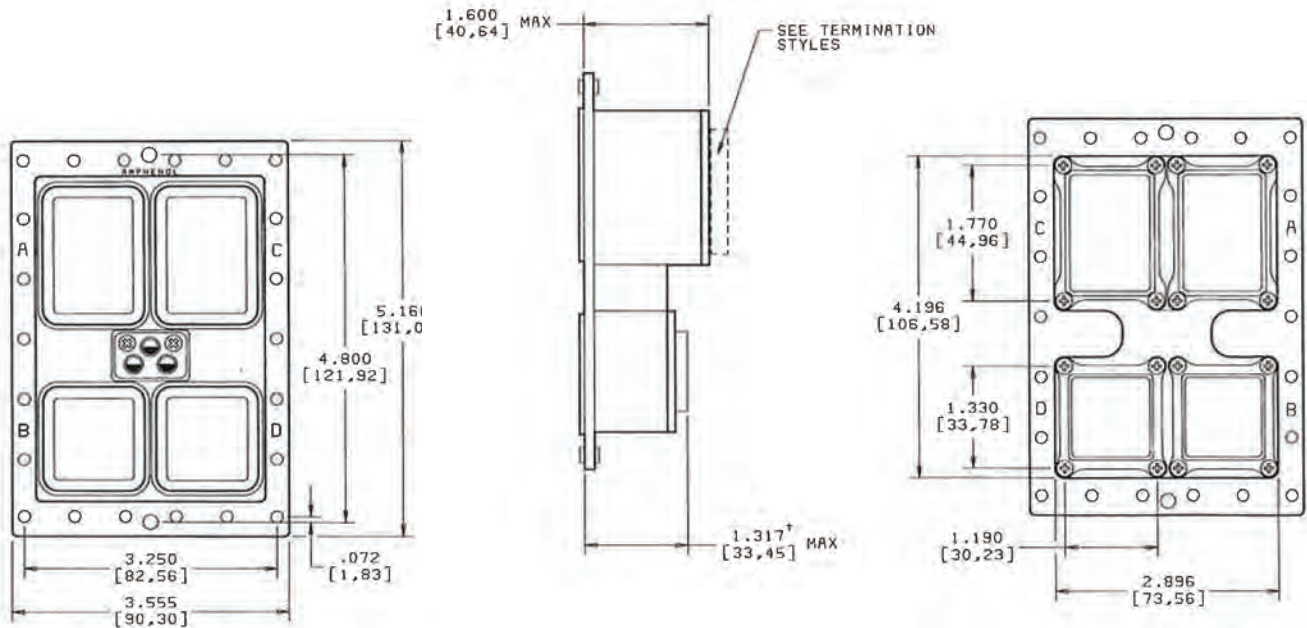

# MIL-DTL-83527 Filter Connectors

## Receptacle Shell Size 4

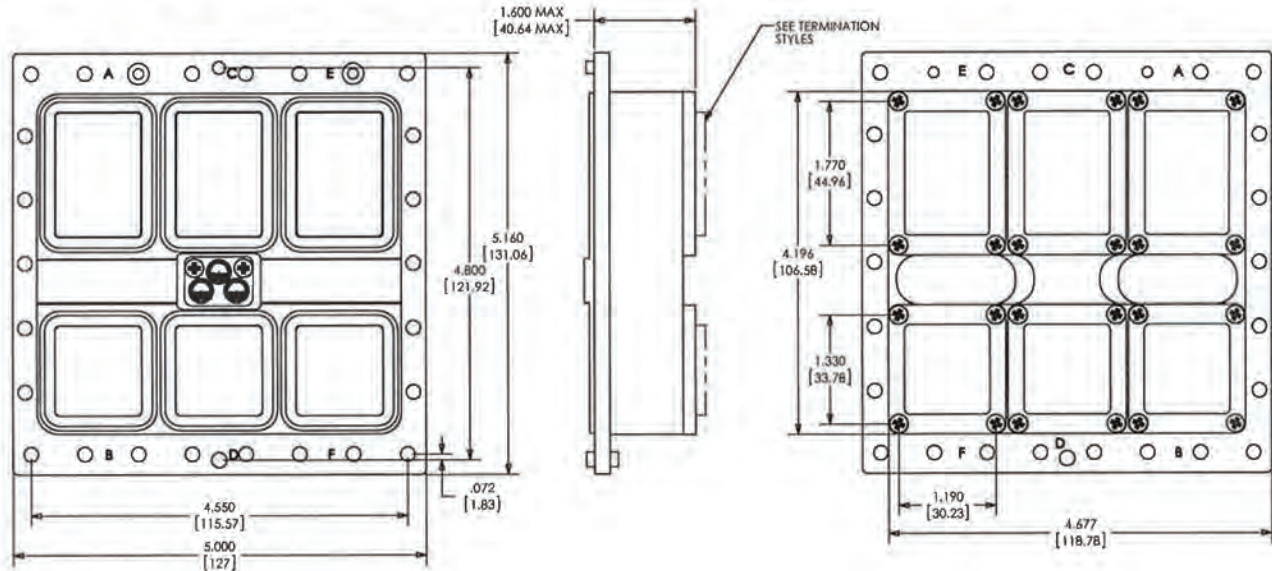

## Receptacle Shell Size 6

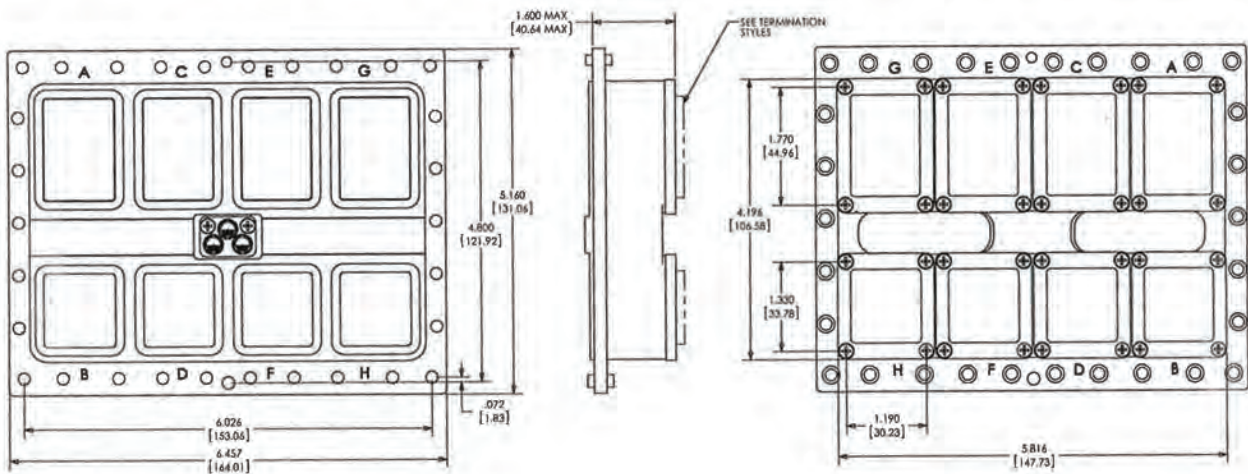

\* This dimension is for all filter styles with PCB, wire wrap or solder cup terminations. For environmental class connectors with rear release contacts, add .600" (15,24mm). Shorter length designs are available. Consult the factory for details.

Note: Size 22D contacts are supplied installed and are removable with Amphenol insertion/removal tool 485-905. Cavity C and F power contacts are packaged separately. Coax and triax contacts may be ordered separately.

ARINC 600 Cavity C and F and MIL-C-83527 Cavity B and D dimensions are shown unfiltered.



# MIL-DTL-83527 Insert Arrangements

## SIGNAL INSERT CAVITIES A, C, E & G

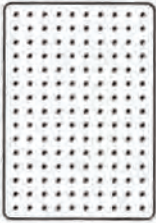

**INSERT 150**  
(150) SIZE 22

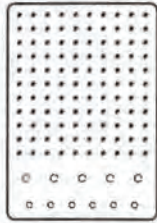

**INSERT 121**  
(110) SIZE 22  
(6) SIZE 20  
(5) SIZE 16

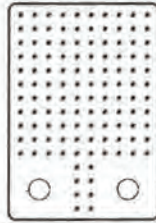

**INSERT 120T2\***  
(118) SIZE 22  
(2) SIZE 8 TWINAX

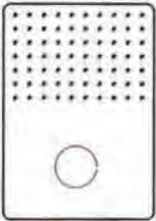

**INSERT 71C1**  
(70) SIZE 22  
(1) SIZE 1 COAX

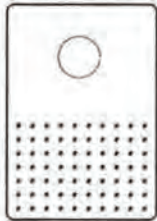

**INSERT 71W1A**  
(70) SIZE 22  
(1) SIZE 1 COAX

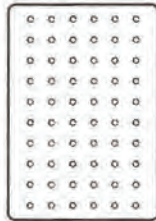

**INSERT 60**  
(60) SIZE 20

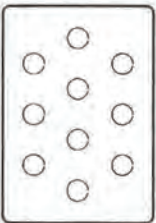

**INSERT 10T10 (METAL)\***  
(10) SIZE 8 TRIAX/COAX

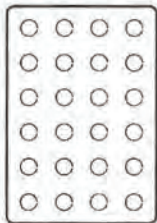

**INSERT 24**  
(24) SIZE 12

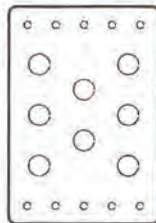

**INSERT 18T8**  
(10) SIZE 16  
(8) SIZE 8 TWINAX

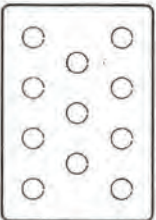

**INSERT 011 (METAL)\***  
(11) SIZE 8 QUADRAX

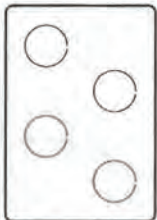

**INSERT 4W4 (METAL)**  
(4) SIZE 1 COAX

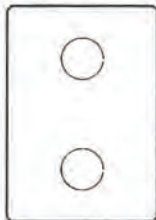

**INSERT 2W2 (METAL)**  
(2) SIZE 1 COAX

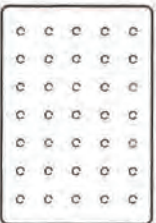

**INSERT 35**  
(35) SIZE 16

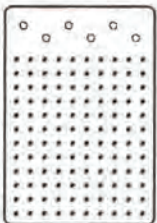

**INSERT 126**  
(120) SIZE 22  
(6) SIZE 16



**BLANK**  
SIGNAL INSERT

## POWER INSERT CAVITIES B, D, F & H

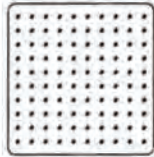

**INSERT 100**  
(100) SIZE 22

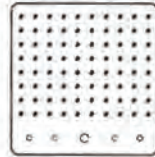

**INSERT 85**  
(80) SIZE 22  
(4) SIZE 20  
(1) SIZE 16

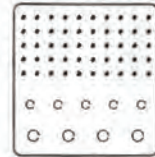

**INSERT 59**  
(50) SIZE 22  
(5) SIZE 16  
(4) SIZE 12

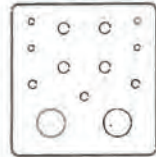

**INSERT 13W2**  
(4) SIZE 20  
(3) SIZE 16  
(4) SIZE 12  
(2) SIZE 5 COAX

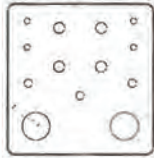

**INSERT 1102\***  
(4) SIZE 20  
(3) SIZE 16  
(4) SIZE 12  
(2) SIZE 8 QUADRAX

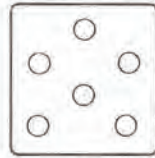

**INSERT 6T6 (METAL)\***  
(6) SIZE 8 TWINAX/COAX

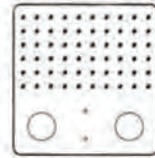

**INSERT 62Q2\***  
(60) SIZE 22  
(2) SIZE 16  
(2) SIZE 8 QUADRAX

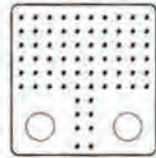

**INSERT 68Q2\***  
(68) SIZE 22  
(2) SIZE 8 QUADRAX

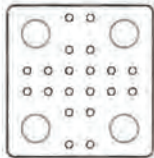

**INSERT 20Q2\***  
(20) SIZE 20  
(4) SIZE 8 QUADRAX

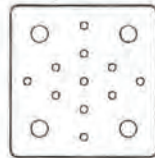

**INSERT 11C4**  
(11) SIZE 16  
(4) SIZE 12

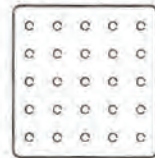

**INSERT 25**  
(25) SIZE 16



**BLANK**  
POWER INSERT

## FIBRE OPTIC INSERTS CAVITIES A, C, E & G



**INSERT 36F36**  
(36) SIZE 16 FIBRE OPTIC

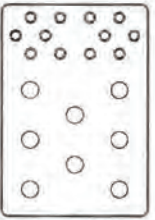

**INSERT 20F12T8**  
(12) SIZE 16 FIBRE OPTIC  
(8) SIZE 8 TWINAX/QUADRAX

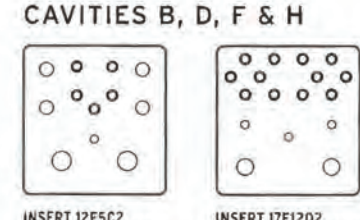

**INSERT 12F5C2**  
(5) SIZE 16 FIBRE OPTIC  
(1) SIZE 16  
(4) SIZE 12  
(2) SIZE 5 COAX

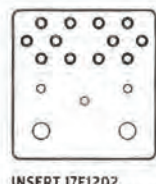

**INSERT 17F12Q2**  
(12) SIZE 16 FIBRE OPTIC  
(3) SIZE 16  
(2) SIZE 8 QUADRAX

## CONTACT LEGEND



\* Consult factory for further availability of insert combinations.

\* Available with Quadrax or Triax/Coax



# Amphenol Canada

## Filter Connectors

### Filter Rectangular Connectors D-Subminiature and Micro D-Subminiature

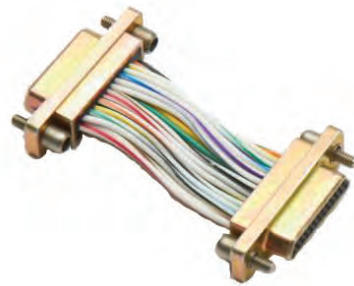

# Amphenol

FILTERED AND RECTANGULAR CONNECTORS

Telephone: (416) 291-4401 Fax: (416) 292-0647 [www.amphenolcanada.com](http://www.amphenolcanada.com)

# MIL-DTL-24308 Filter D-Subminiature Connectors

Amphenol Canada's Filtered D-subminiature connectors for high reliability applications uses a stress isolated design without incorporating solder to allow for the rugged transfer of shock and vibration waveforms without damage to the filter elements. All sizes and termination styles are available with short lead times to meet the military and commercial aviation markets.

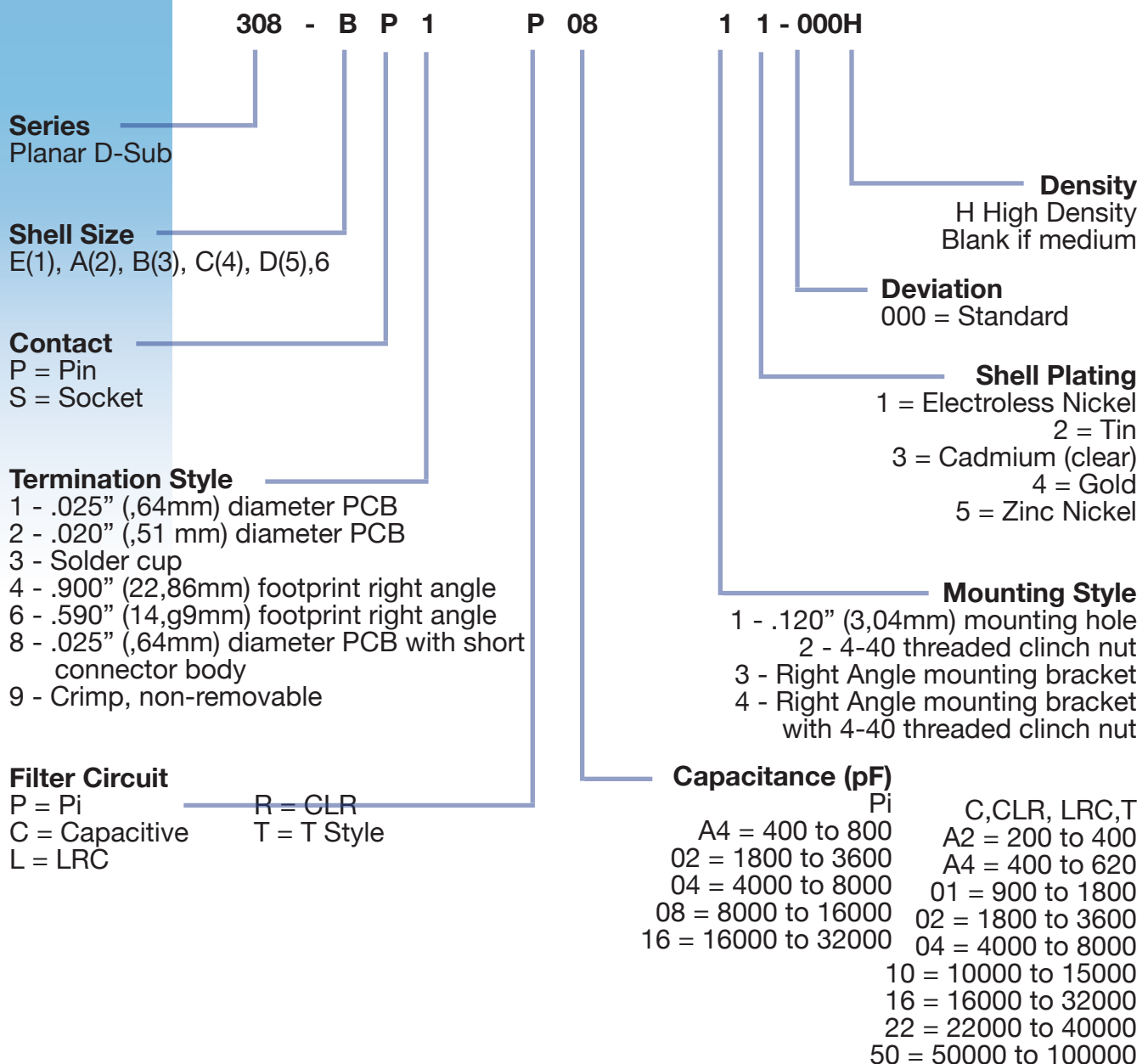

# 308 Series Plug Dimensions

## D-Subminiature Filter Connectors

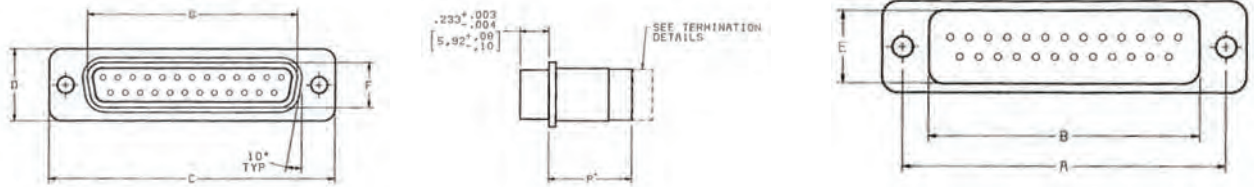

Front View

Side View

Rear View

Shell Size	Number of Contacts	Dimension													
		A		B Max		C		D Max		E Max		F		G	
		±.005"	±.13mm	inches	mm	±.015"	±.38mm	inches	mm	inches	mm	±.005"	±.13mm	±.005"	±.13mm
E	9 or 15	0.984	24,99	0.685	17,34	1.213	30,81	0.534	13,56	0.434	11,02	0.329	8,36	0.666	16,92
A	15 or 26	1.312	33,32	1.009	25,63	1.541	39,14	0.534	13,56	0.434	11,02	0.329	8,36	0.994	25,25
B	25 or 44	1.852	47,04	1.557	39,55	2.088	53,04	0.534	13,56	0.434	11,02	0.329	8,36	1.534	38,96
C	37 or 62	2.500	63,50	2.205	56,01	2.729	69,32	0.534	13,56	0.434	11,02	0.329	8,36	2.182	55,42
D	50 or 78	2.406	61,11	2.110	53,59	2.635	66,93	0.641	16,28	0.541	13,74	0.441	11,20	2.079	52,81
6	104	2.500	63,50	2.255	57,28	2.729	69,32	0.680	17,27	0.640	16,26	0.503	12,77	2.212	56,18

# 308 Series Receptacle Dimensions

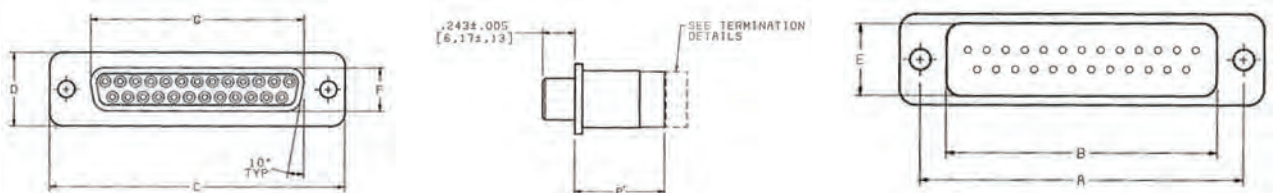

Front View

Side View

Rear View

Shell Size	Number of Contacts	Dimension													
		A		B Max		C		D Max		E Max		F		G	
		±.005"	±.13mm	inches	mm	±.015"	±.38mm	inches	mm	inches	mm	±.005"	±.13mm	±.005"	±.13mm
E	9 or 15	0.984	24,99	0.685	17,34	1.213	30,81	0.534	13,56	0.434	11,02	0.311	7,90	0.643	16,33
A	15 or 26	1.312	33,32	1.009	25,63	1.541	39,14	0.534	13,56	0.434	11,02	0.311	7,90	0.971	24,66
B	25 or 44	1.852	47,04	1.557	39,55	2.088	53,04	0.534	13,56	0.434	11,02	0.311	7,90	1.511	38,38
C	37 or 62	2.500	63,50	2.205	56,01	2.729	69,32	0.534	13,56	0.434	11,02	0.311	7,90	2.159	54,84
D	50 or 78	2.406	61,11	2.110	53,59	2.635	66,93	0.641	16,28	0.541	13,74	0.423	10,74	2.064	52,43
6	104	2.500	63,50	2.255	57,28	2.729	69,32	0.680	17,27	0.640	16,26	0.485	12,32	2.189	55,60



# 308 Series Insert Arrangements

Pin Engaging Face Shown

## Shell Size 1 (E)

Medium Density



9 #20 Contacts

High Density



15 #22 Contacts

## Shell Size 2 (A)

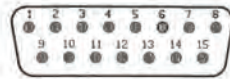

15 #20 Contacts



26 #22 Contacts

## Shell Size 3 (B)

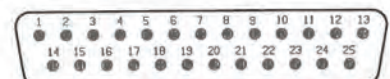

25 #20 Contacts

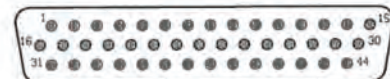

44 #22 Contacts

## Shell Size 4 (C)

Medium Density

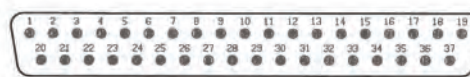

37 #20 Contacts

High Density



62 #22 Contacts

## Shell Size 5 (D)

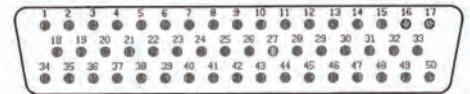

50 #20 Contacts



78 #22 Contacts

## Shell Size 6



104 #22 Contacts

**Note:** Consult the factory for other insert patterns.

## Recommended Panel Cutout Front and Rear Mounting

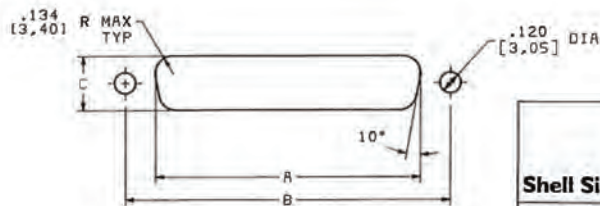

Shell Size	Dimension					
	A min		B		C min	
	inches	mm	±.005"	±.13mm	inches	mm
<b>1 (E)</b>	0.801	20,35	0.984	24,99	0.449	11,40
<b>2 (A)</b>	1.129	28,68	1.312	33,32	0.449	11,40
<b>3 (B)</b>	1.669	42,39	1.852	47,04	0.449	11,40
<b>4 (C)</b>	2.321	58,95	2.500	63,50	0.449	11,40
<b>5 (D)*</b>	2.213	56,21	2.406	61,11	0.555	14,09
<b>5 (D)+</b>	2.250	57,15	2.406	61,11	0.585	14,86
<b>6 *</b>	2.360	59,94	2.500	63,50	0.630	16,00

\* Rear mounting dimensions.  
+ Front mounting dimensions.



# 308 Series Termination Styles

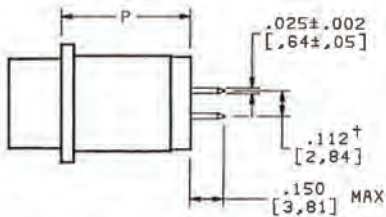

Termination Style 1

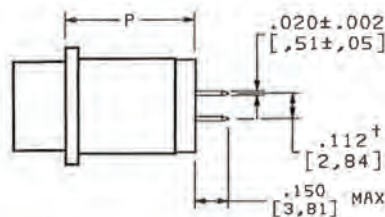

Termination Style 2

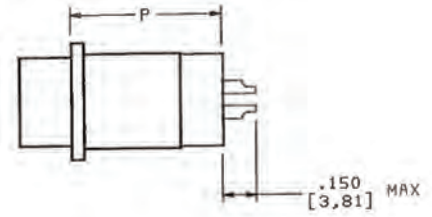

Termination Style 3

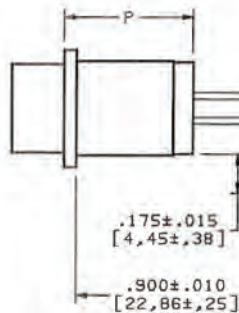

Termination Style 4

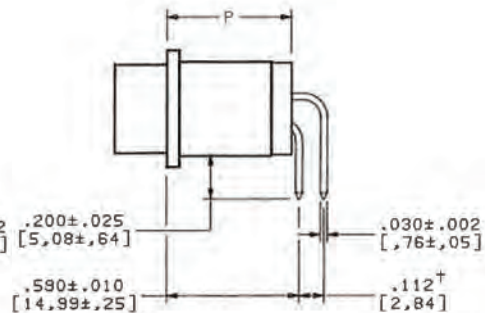

Termination Style 6

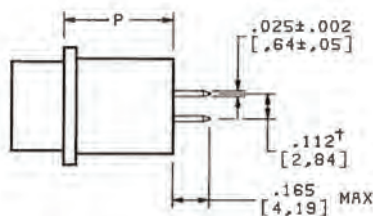

Termination Style 8

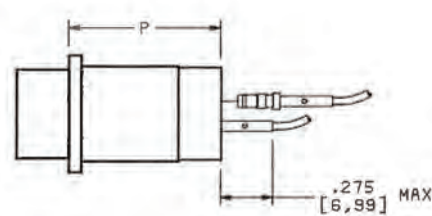

Termination Style 9

This dimension is 0.078" (1,98) for high density arrangements.

Filter Circuit	Termination Style and Shell Length (P Max dimension)													
	1 and 2		3		4		6		7		8		9	
	inches	mm	inches	mm	inches	mm	inches	mm	inches	mm	inches	mm	inches	mm
PI,LRC,CLR,T	0.575	14,61	0.695	17,65	0.575	14,61	0.575	14,61	N/A	N/A	0.470	11,94	0.695	17,65
C	0.450	11,43	0.570	14,48	0.450	11,43	0.450	11,43	0.400	10,16	0.370	9,40	0.570	14,48

# 308 Series Mounting Styles

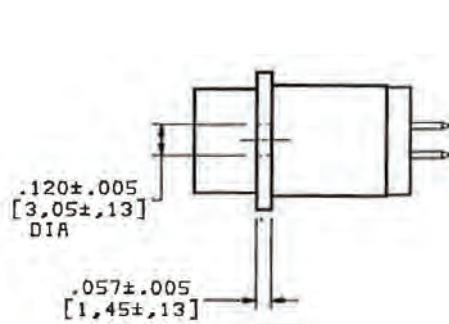

**Mounting Style 1**

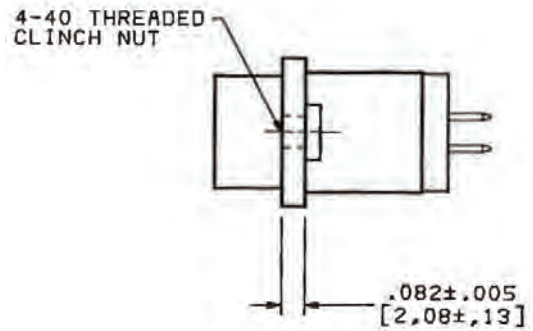

**Mounting Style 2**

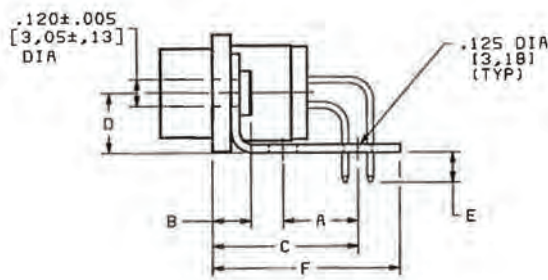

**Mounting Style 3 (two row)**

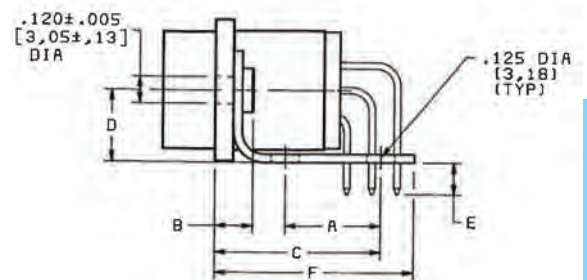

**Mounting Style 3 (three row)**

Shell Size	Number of Contacts	Dimension											
		A		B Max		C		D		E		F Max	
		±.004"	±.11mm	inches	mm	±.015"	±.39mm	±.008"	±.21mm	±.020"	±.51mm	inches	mm
E	9 or 15	0.331	8,41	0.250	6,35	0.647	16,43	0.270	6,86	0.149	3,79	0.855	21,72
A	15 or 26	0.331	8,41	0.250	6,35	0.647	16,43	0.270	6,86	0.149	3,79	0.855	21,72
B	25 or 44	0.331	8,41	0.250	6,35	0.647	16,43	0.270	6,86	0.149	3,79	0.855	21,72
C	37 or 62	0.331	8,41	0.250	6,35	0.647	16,43	0.270	6,86	0.149	3,79	0.855	21,72
D	50 or 78	0.387	9,83	0.250	6,35	0.703	17,86	0.324	8,23	0.149	3,79	0.910	23,12

# Industrial Grade Filter D

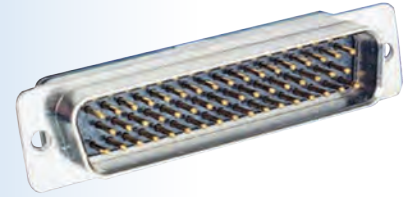

Amphenol Canada's FD308 connectors are available in the full range of standard and high-density arrangements, either pin or socket. These connectors are supplied with fixed screw machine contacts and are available in Solder Cup, Straight or Right Angle PCB terminations.

**Applications:**

- Computers and Peripheral Equipment
- Ideal for Retrofit Applications or Late Design-In

**Specifications**

*Product Features:*

- Hi reliability filtering in multi row arrangements
  - Stamped and formed shells
- Screw machine contacts and hi reliability inserts
  - Available in all hi-density insert patterns
  - Mates with MIL-DTL-24308 D-Subs

*Electrical Ratings:*

Current	5 A
Insulation Resistance	5 GΩ @ 200 Vdc
Working Voltage	200 Vdc
D.W.V.	500 Vdc PIN-PIN/PIN-Shell
Capacitance	+/- 20%
Temperature	-55°C/+125°C

*Materials and Platings:*

Shells	Stamped steel shell, tin plated
Inserts	High temperature resistant polyethersulfone per MIL-P-46185
Contacts	Machined copper alloy, 20μ" gold over nickel
Capacitor	Barium titanate ceramic array

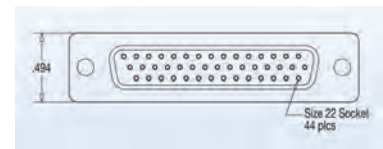
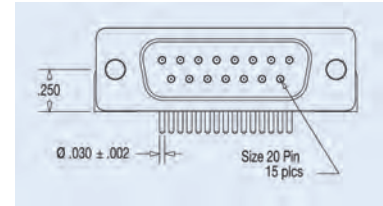
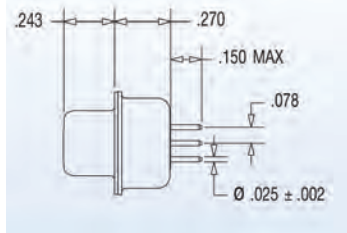
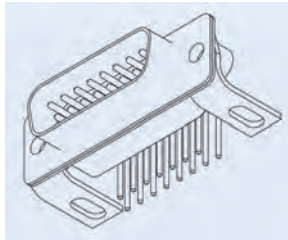
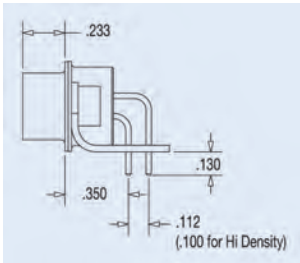

FD308 - B44 S A 1 A2 - 000

**Size & Number of Contacts**

STD Density E09, A15, B25, C37, D50  
High Density E15, A26, B44, C62, D78, 6104

**Contact Type**

S = Socket Contact (Receptacle)  
P = Pin Contact (Plug)

**Termination Style**

A = Right Angle PCB  
B = Vertical PCB  
C = Solder Cup

000 = Standard part  
other deviations as required

**Capacitance Code**

A2 = 200 pF                      A4 = 400 pF  
01 = 1000 pF                      02 = 2000 pF  
05 = 5000 pF

**Mounting Type**

1 = 4-40 Clinch Nut  
2 = Ø.120 thru hole  
3 = R/A Mounting Bracket  
4 = 4-40 Clinch Nut with R/A Mounting Bracket

# MIL-DTL-83513 Filter Connectors

## FEATURES

Amphenol Canada's M13 connector series is a range of filtered MIL-DTL-83513 Micro-D products for military and aerospace applications. These extremely small filter connectors employ monolithic planar capacitors in a rugged, high density package ideally suited for applications where space and weight is restricted. Available in a variety of filter types and mechanical configurations including wired harnesses and PCB terminations. The M13 series are fully intermateable with all standard MIL-DTL-83513 connectors and meet the applicable performance and environmental requirements.

### M13 21 P 1 2 P T C 1 1 - 000

**Connector Series**

M13 = Filtered micro-d

**Connector Size (number of contacts)**

09, 15, 21, 25, 31 and 37

**Connector Type**

P = Plug (pin)  
S = Receptacle (socket)

**Termination Type**

1 = vertical PCB "BS"  
2 = vertical PCB "C6"  
4 = right angle PCB "CBR"  
5 = solid wire straight  
6 = stranded wire

**Wire / Lead Length (inches)**

1 = .109 +/- .015  
2 = .140 +/- .015  
3 = .172 +/- .015  
4 = .250 +/- .015

**For Termination Type 6 (inches +1.00/-0.00):**

A = 18.00 per M22759/11-26 (mil-std-681, system 1)  
B = 36.00 per M22759/11-26 (mil-std-681, system 1)  
C = 72.00 per M22759/11-26 (mil-std-681, system 1)

**Deviation**  
XXX (000 is standard part)

**Plating**  
1 = Electroless Nickel  
2 = Tin  
3 = Cadmium (Clear Chromate)  
4 = Gold  
5 = Zn Ni

**Filter Value ( pF +100%/-0%)**  
A = 200  
B = 400  
C = 800  
1 = 1000  
2 = 2000  
4 = 4000  
8 = 8000  
T = 10,000  
H = 16,000  
0 = MIXED CAP

**Filter Type**  
P = Pi-Filter  
C = C-Filter  
0 = non-filtered equivalent part

**Insert Option**  
T = Threaded Insert (PCB terminations only)  
*Omit if not used*

**Mounting Hardware**  
A = .093" diameter mounting hole  
B = .125" diameter mounting hole  
L = Jackpost (loose)  
P = Jackpost (fixed)



# MIL-DTL-83513 Filter Connectors

## C-FILTER SPECIFICATIONS

Filter Circuits		C, CLR, LFC					
Capacitance (pF) (@ 25 C, 1 kHz and 1.0 VRMS)		150 TO 300	300 TO 500	600 TO 1200	1200 TO 3200	4000 TO 8000	8000 TO 16000
Insertion Loss (dB min.)	.1 MHz	-	-	-	-	-	-
(per MIL-STD-220	1 MHz	-	-	-	-	-	-
@ 25 C and no load)	10 MHz	-	-	2	5	13	18
	100 MHz	6	12	17	24	33	40
	1000 MHz	25	31	38	43	54	60
Working Voltage (VDC) (@ 25 C & sea level)		100					
Dielectric Withstanding Voltage (VDC) (@ 25 C and 50 mA max. charging current)		300					
Insulation Resistance (Gohms)							
(@ 25 C and working voltage)		5					
Contact Current Rating (continuous max. DC amperes)		3					
Filter RF Current Rating (amperes) (max. @ any frequency)		0.3					

## PI-FILTER SPECIFICATIONS

Filter Circuits		PI					
Capacitance (pF) (@ 25 C, 1 kHz and 1.0 VRMS)		150 TO 300	300 TO 500	600 TO 1200	1200 TO 3200	4000 TO 8000	8000 TO 16000
Insertion Loss (dB min.)	.1 MHz	-	-	-	-	-	-
(per MIL-STD-220	1 MHz	-	-	-	-	-	3
@ 25 C and no load)	10 MHz	-	-	2	5	13	18
	100 MHz	7	12	18	26	45	57
	1000 MHz	30	42	53	60	60	60
Working Voltage (VDC) (@ 25 C & sea level)		100					
Dielectric Withstanding Voltage (VDC) (@ 25 C and 50 mA max. charging current)		300					
Insulation Resistance (Gohms)							
(@ 25 C and working voltage)		5					
Contact Current Rating (continuous max. DC amperes)		3					
Filter RF Current Rating (amperes) (max. @ any frequency)		0.3					

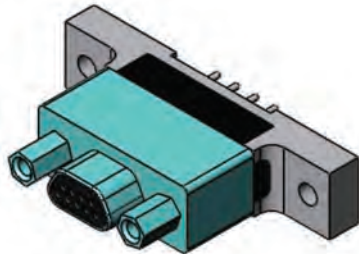

TERMINATION TYPE 1  
VERTICAL PCB "BS"

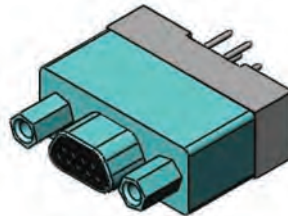

TERMINATION TYPE 2  
VERTICAL PCB "C6"

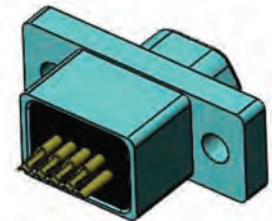

TERMINATION TYPE 3  
SOLDER CUP

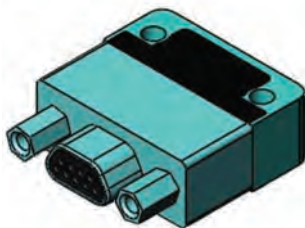

TERMINATION TYPE 4  
RIGHT ANGLE PCB  
"CBR"

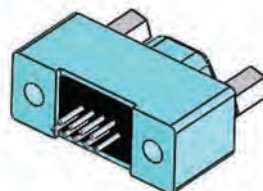

TERMINATION TYPE 5  
SOLID WIRE STRAIGHT

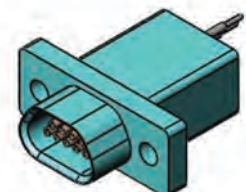

TERMINATION TYPE 6  
STRANDED WIRE

# MIL-DTL-83513 Filter Connectors

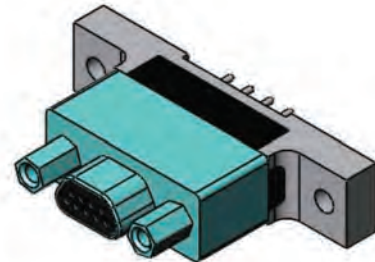
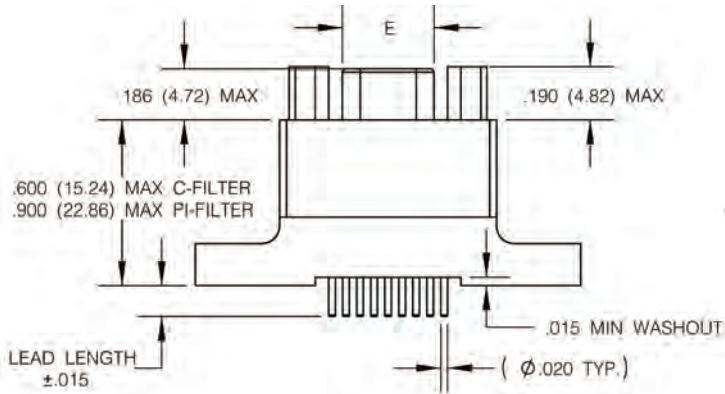

PLUG

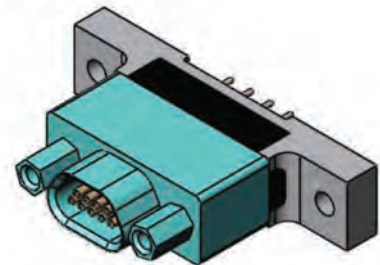
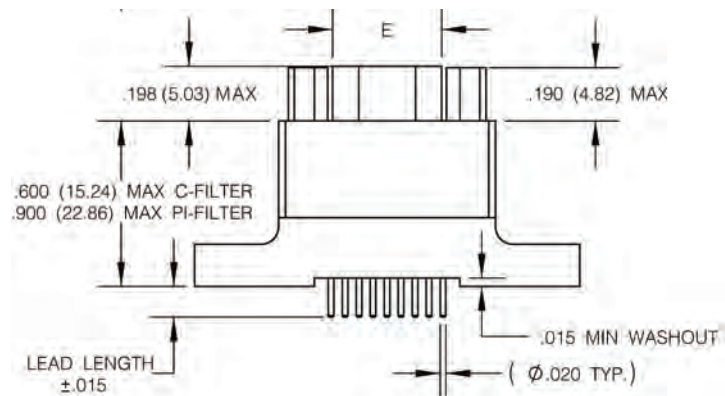

RECEPTACLE

\* INTERFACIAL SEAL INCLUDED

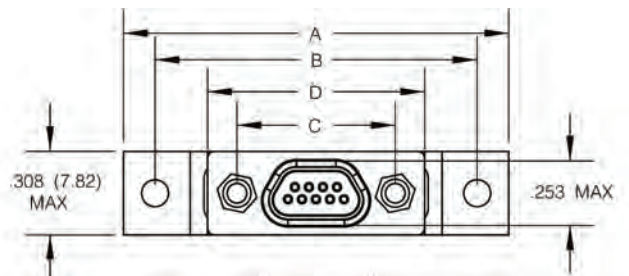
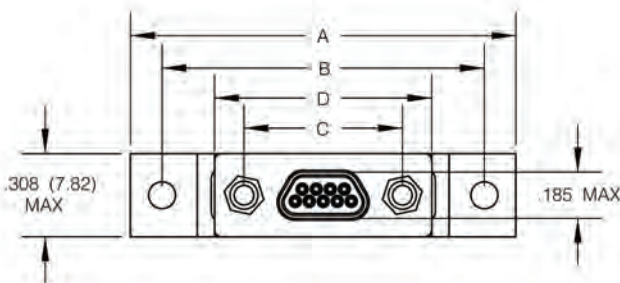

SIZE	A MAX	B $\pm .005$ (0.13)	C $\pm .005$ (0.13)	D MAX	E MAX	
					PLUG	RCPT
09	1.390 (35.31)	1.150 (29.21)	.565 (14.35)	.785 (19.84)	.334 (8.48)	.402 (10.21)
15	1.390 (35.31)	1.150 (29.21)	.715 (18.16)	.935 (23.75)	.484 (12.29)	.552 (13.97)
21	1.690 (43.93)	1.450 (36.83)	.865 (21.97)	1.085 (27.56)	.634 (16.10)	.702 (17.83)
25	1.740 (44.20)	1.500 (38.10)	.965 (24.51)	1.185 (30.10)	.734 (18.64)	.802 (20.37)
31	2.040 (51.82)	1.800 (45.72)	1.115 (28.32)	1.335 (33.91)	.884 (22.45)	.952 (24.18)
37	2.340 (59.44)	2.100 (53.34)	1.265 (32.13)	1.485 (37.72)	1.034 (26.26)	1.102 (27.99)



# MIL-DTL-83513 Filter Connectors

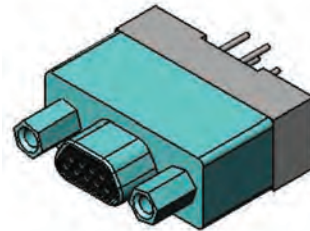
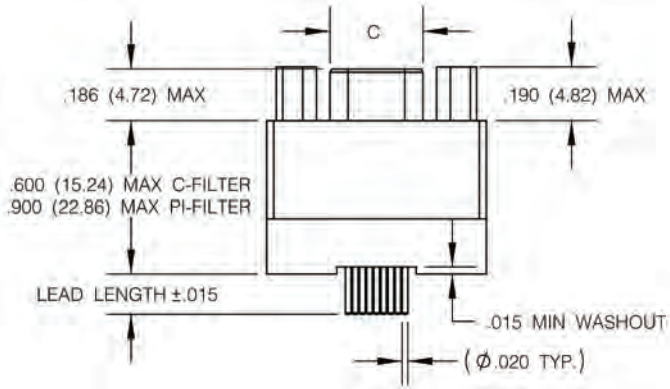

PLUG

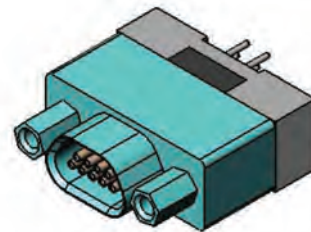
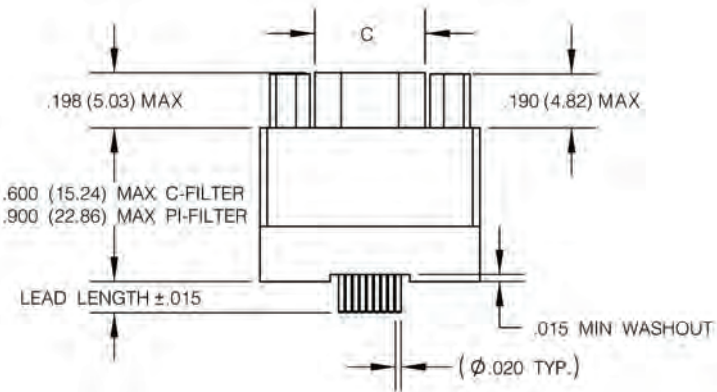

RECEPTACLE  
\* INTERFACIAL SEAL INCLUDED

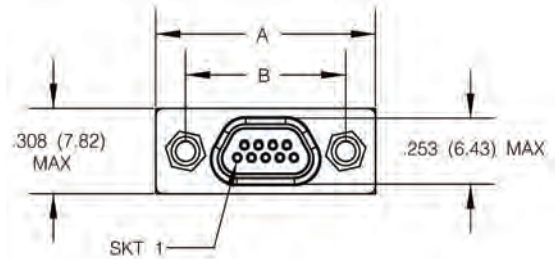
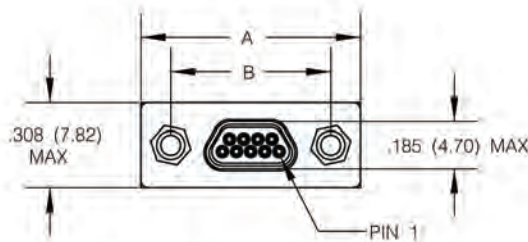

SIZE	A MAX	B ±.005 (0.13)	C MAX	
			PLUG	RCPT
09	.785 (19.94)	.565 (14.35)	.334 (8.48)	.402 (10.21)
15	.935 (23.75)	.715 (18.16)	.484 (12.29)	.552 (13.97)
21	1.085 (27.56)	.865 (21.97)	.634 (16.10)	.702 (17.83)
25	1.185 (30.10)	.965 (24.51)	.734 (18.64)	.802 (20.37)
31	1.335 (33.91)	1.115 (28.32)	.884 (22.45)	.952 (24.18)
37	1.485 (37.72)	1.265 (32.13)	1.034 (26.26)	1.102 (27.99)



# MIL-DTL-83513 Filter Connectors

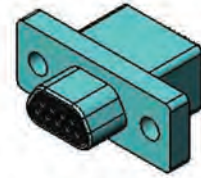
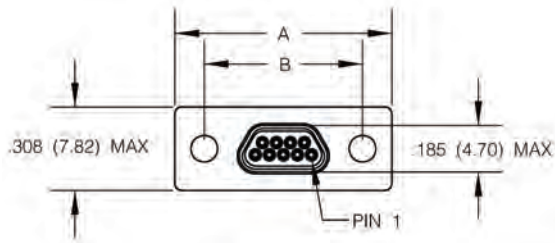

PLUG

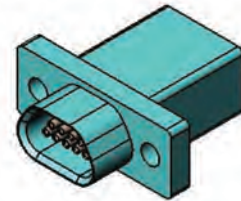
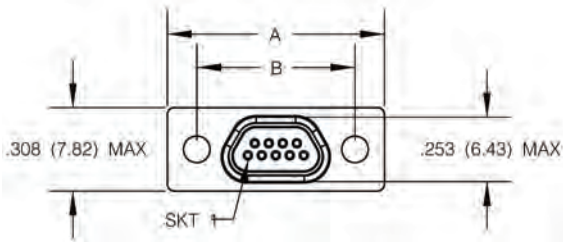

RECEPTACLE

\* INTERFACIAL SEAL INCLUDED

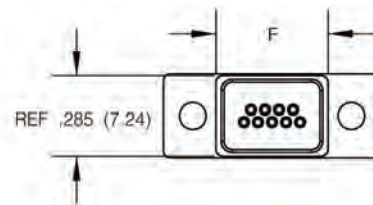
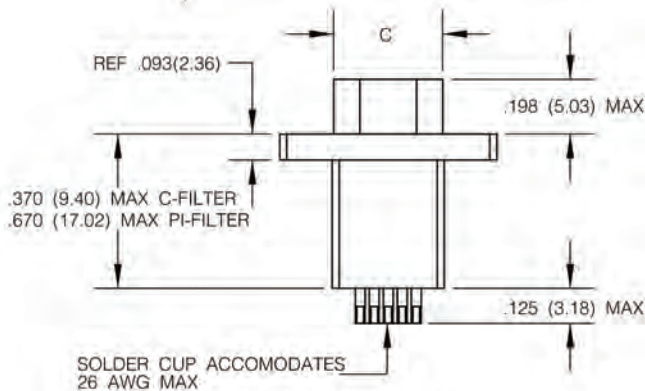
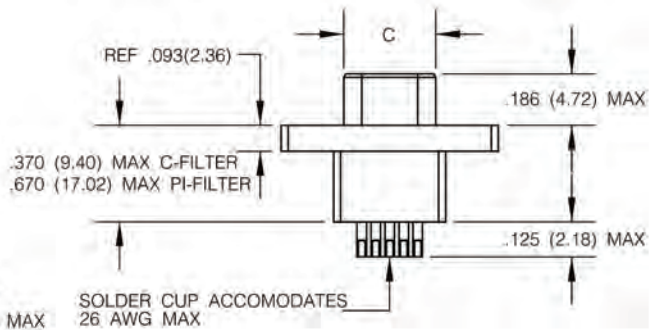
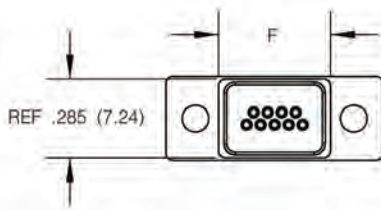

SIZE	A MAX	B ±.005 (0.13)	C MAX		F MAX
			PLUG	RCPT	
09	.785 (19.94)	.565 (14.35)	.334 (8.48)	.402 (10.21)	.400 (10.16)
15	.935 (23.75)	.715 (18.16)	.484 (12.29)	.552 (13.97)	.550 (13.97)
21	1.085 (27.56)	.865 (21.97)	.634 (16.10)	.702 (17.83)	.700 (17.78)
25	1.185 (30.10)	.965 (24.51)	.734 (18.64)	.802 (20.37)	.800 (20.32)
31	1.335 (33.91)	1.115 (28.32)	.884 (22.45)	.952 (24.18)	.950 (24.13)
37	1.485 (37.72)	1.265 (32.13)	1.034 (26.26)	1.102 (27.99)	1.100 (27.94)

# MIL-DTL-83513 Filter Connectors

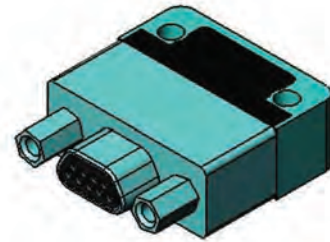
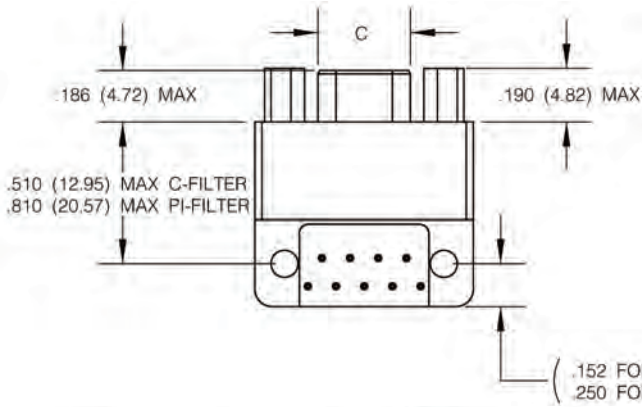

PLUG

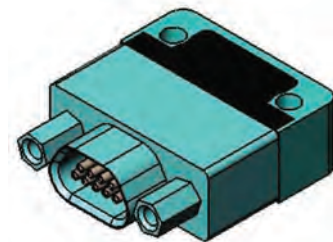
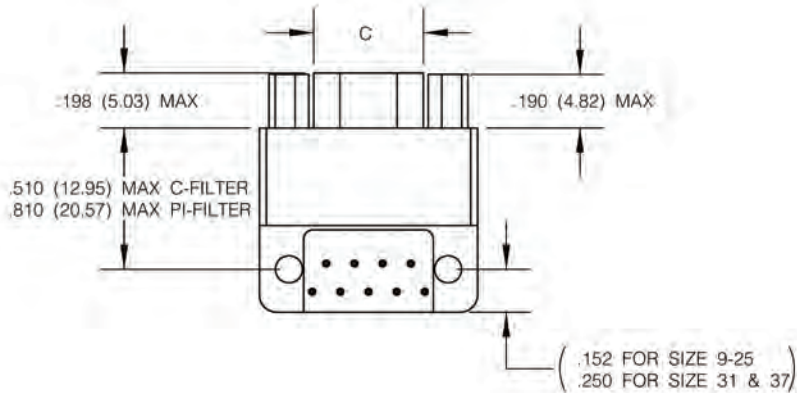

RECEPTACLE  
\* INTERFACIAL SEAL INCLUDED

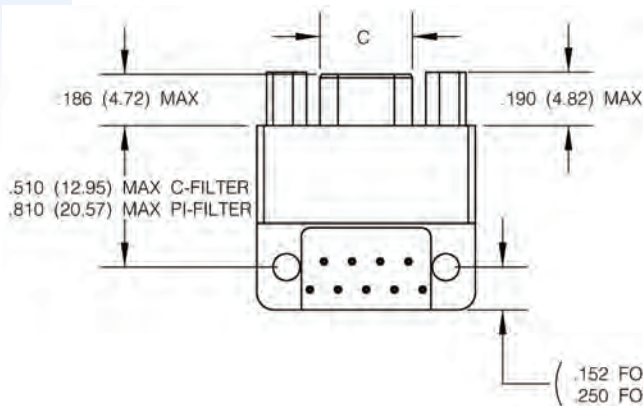
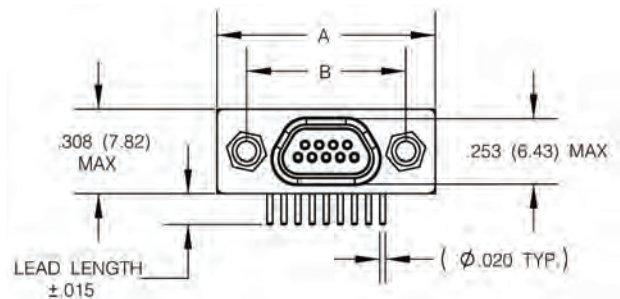
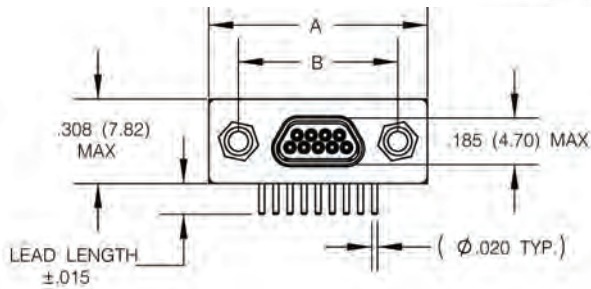

SIZE	A MAX	B ±.005 (0.13)	C MAX	
			PLUG	RCPT
09	.785 (19.94)	.565 (14.35)	.334 (8.48)	.402 (10.21)
15	.935 (23.75)	.715 (18.16)	.484 (12.29)	.552 (13.97)
21	1.085 (27.56)	.865 (21.97)	.634 (16.10)	.702 (17.83)
25	1.185 (30.10)	.965 (24.51)	.734 (18.64)	.802 (20.37)
31	1.335 (33.91)	1.115 (28.32)	.884 (22.45)	.952 (24.18)
37	1.485 (37.72)	1.265 (32.13)	1.034 (26.26)	1.102 (27.99)



# MIL-DTL-83513 Filter Connectors

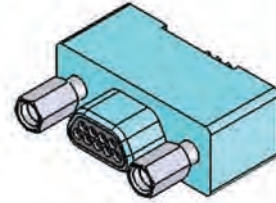
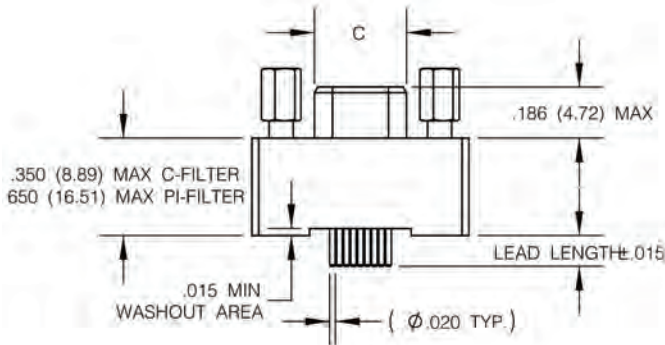

PLUG

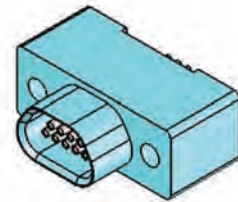
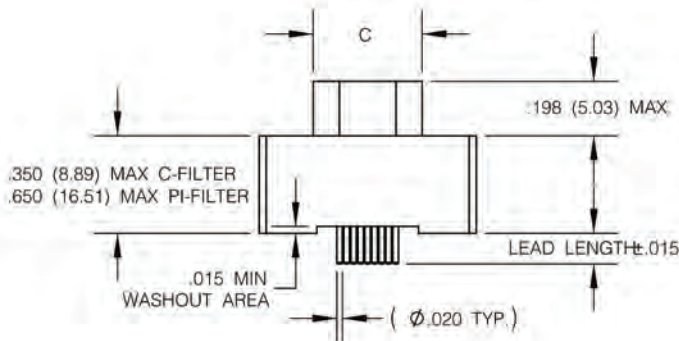

RECEPTACLE  
\* INTERFACIAL SEAL INCLUDED

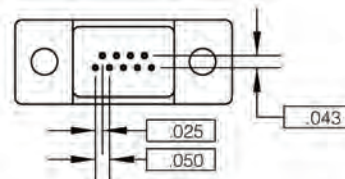
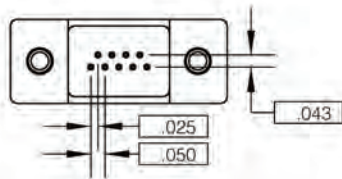
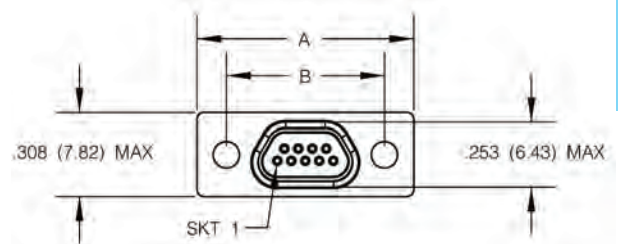
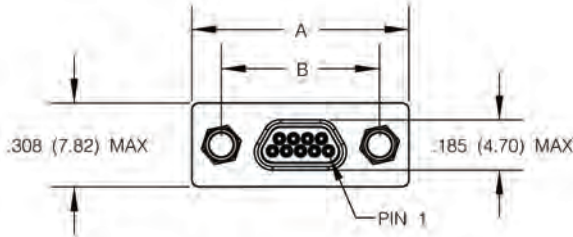

SIZE	A MAX	B $\pm .005$ (0.13)	C MAX	
			PLUG	RCPT
09	.785 (19.94)	.565 (14.35)	.334 (8.48)	.402 (10.21)
15	.935 (23.75)	.715 (18.16)	.484 (12.29)	.552 (13.97)
21	1.085 (27.56)	.865 (21.97)	.634 (16.10)	.702 (17.83)
25	1.185 (30.10)	.965 (24.51)	.734 (18.64)	.802 (20.37)
31	1.335 (33.91)	1.115 (28.32)	.884 (22.45)	.952 (24.18)
37	1.485 (37.72)	1.265 (32.13)	1.034 (26.26)	1.102 (27.99)



# Amphenol Canada

## Filter Connectors

### Filter Circular Connectors



# Amphenol

FILTERED AND RECTANGULAR CONNECTORS

Telephone: (416) 291-4401 Fax: (416) 292-0647 [www.amphenolcanada.com](http://www.amphenolcanada.com)

# MIL-DTL-38999 Filter Connectors

MIL-DTL-38999 filter connectors from Amphenol Canada are designed and manufactured to meet or exceed the requirements of Series I, II, III and IV. All ACC filter connectors are intermateable and interchangeable with standard non-filtered MIL-DTL-38999 connectors unless otherwise specified.

## Material and Finishes

Shell – Aluminum alloy/ Stainless Steel  
 Insulator – High grade plastic  
 Contacts – Copper alloy, gold plate  
 Grommets and Seal – Silicone based elastomer

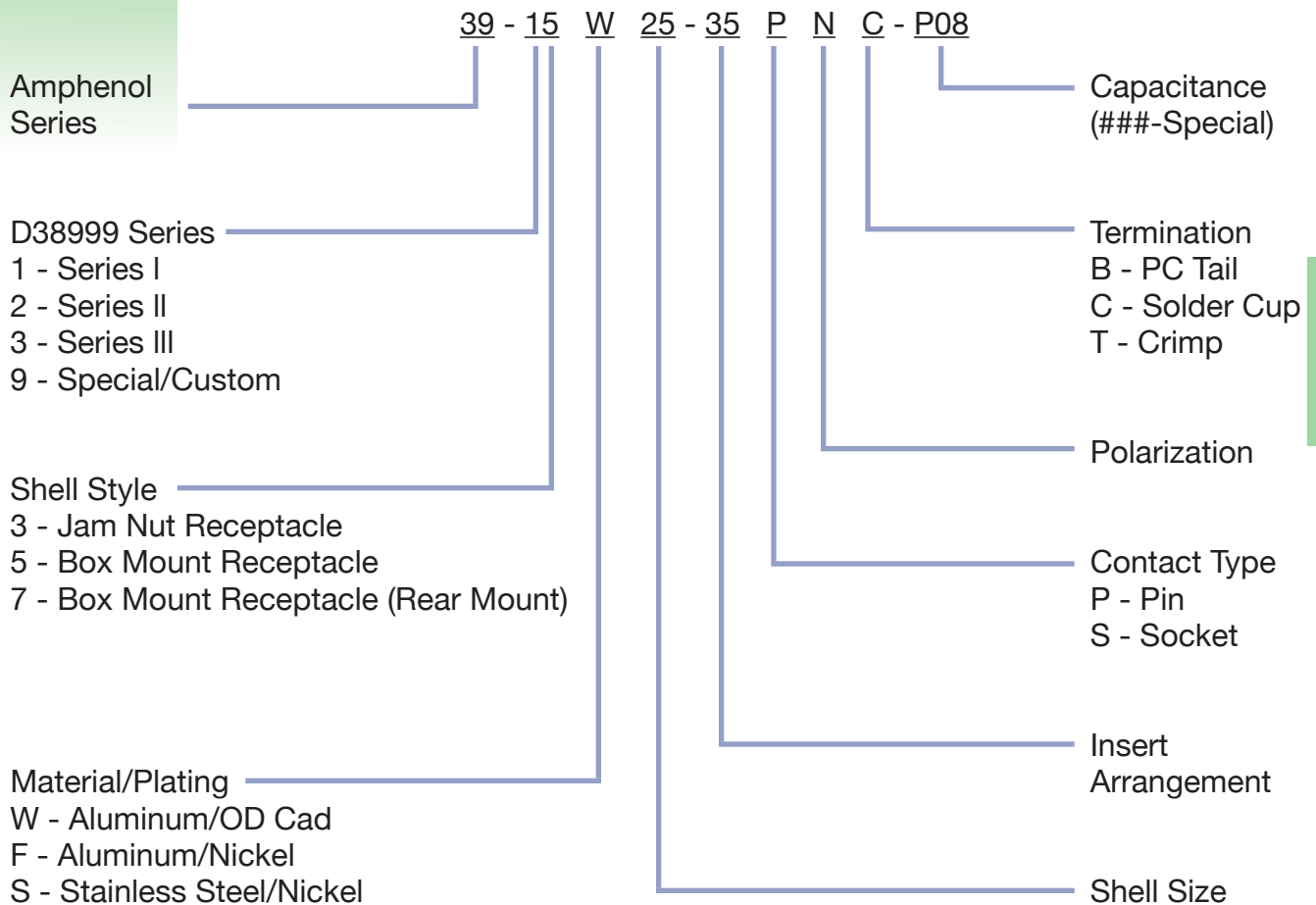

# MIL-DTL-38999 Series I

## MS27466 Box Mount Receptacle

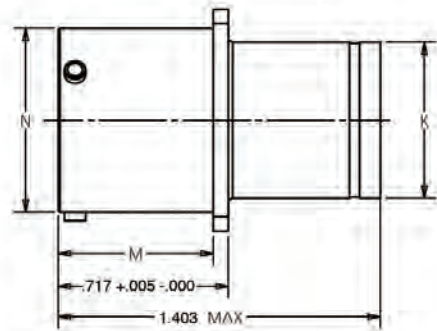
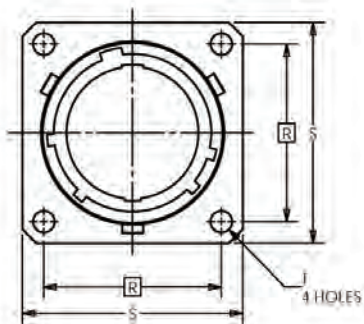
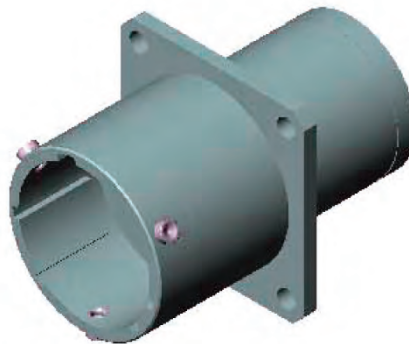

Shell Size	K Dia. =.001 -.006	M =.000 -.006	N Dia. =.001 -.005	R (TP)	S =.011 -.010	T Dia. ±.005
9	.436	.632	.572	.719	.938	.128
11	.560	.632	.700	.812	1.031	.128
13	.686	.632	.850	.906	1.125	.128
15	.810	.632	.975	.969	1.219	.128
17	.936	.632	1.100	1.062	1.312	.128
19	1.060	.632	1.207	1.156	1.438	.128
21	1.186	.602	1.332	1.250	1.562	.128
23	1.310	.602	1.457	1.375	1.688	.147
25	1.436	.602	1.582	1.500	1.812	.147

All dimensions for reference only.



# MIL-DTL-38999 Series I

## MS27505 Box Mount Rear Mount Receptacle

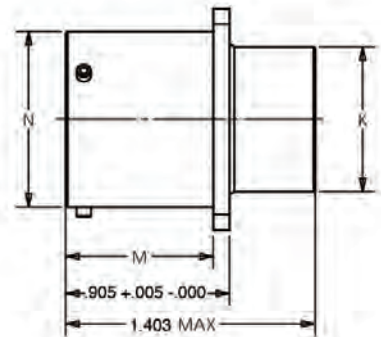
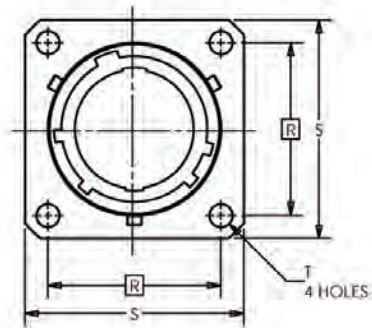
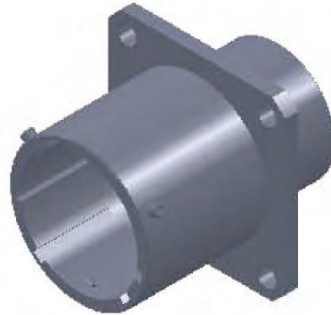

Shell Size	M +.000 =-.006	N Dia. +.001 -.005	R (TP)	S +.011 -.010	T Dia. ±.005	V Thread UNEF-2A (Plated)
9	.632	.572	.719	.938	.128	.4375-28
11	.632	.700	.812	1.031	.128	.5625-24
13	.632	.850	.906	1.125	.128	.6875-24
15	.632	.975	.969	1.219	.128	.8125-20
17	.632	1.100	1.062	1.312	.128	.9375-20
19	.632	1.207	1.156	1.438	.128	1.0625-18
21	.602	1.332	1.250	1.562	.128	1.1875-18
23	.602	1.457	1.375	1.688	.147	1.3125-18
25	.602	1.582	1.500	1.812	.147	1.4375-18

All dimensions for reference only.

# MIL-DTL-38999 Series I

## MS27468 Jam Nut Receptacle

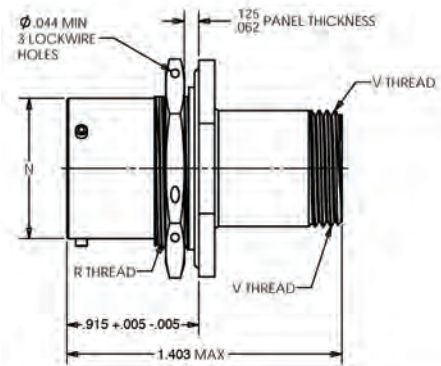
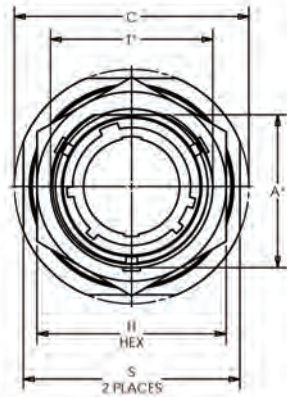
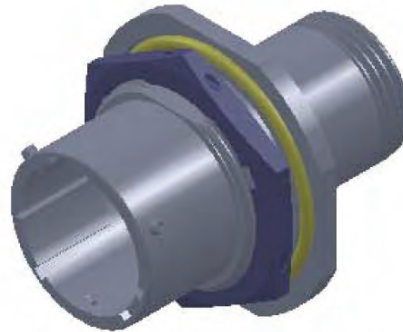

Shell Size	A* Flat +.000 -.010	C Dia. +.011 -.010	H Hex +.017 -.016	N Dia. +.001 -.005	R Thread (Plated) Class -2A	S +.016 -.015	T* Dia. +.010 -.000	V Thread UNEF-2A (Plated)
9	.669	1.188	.875	.572	.6875-24UNEF	1.062	.697	.4375-28
11	.769	1.375	1.000	.700	.8125-20UNEF	1.250	.822	.5625-24
13	.955	1.500	1.188	.850	1.0000-20UNEF	1.375	1.007	.6875-24
15	1.084	1.625	1.312	.975	1.1250-18UNEF	1.500	1.134	.8125-20
17	1.208	1.750	1.438	1.100	1.2500-18UNEF	1.625	1.259	.9375-20
19	1.333	1.938	1.562	1.207	1.3750-18UNEF	1.812	1.384	1.0625-18
21	1.459	2.062	1.688	1.332	1.5000-18UNEF	1.938	1.507	1.1875-18
23	1.580	2.188	1.812	1.457	1.6250-18UNEF	2.062	1.634	1.3125-18
25	1.709	2.312	2.000	1.582	1.7500-18UNS	2.188	1.759	1.4375-18

All dimensions for reference only.

# MIL-DTL-38999 Series II

## MS27499 Box Mount Receptacle

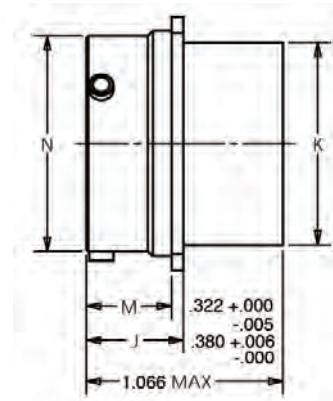
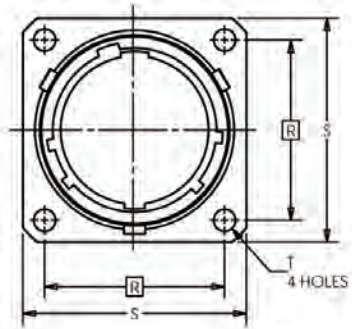
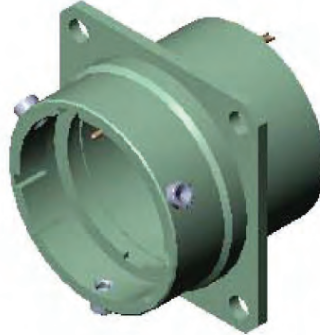

Shell Size	N Dia. +.001 -.005	P* Max.	R (TP)	S +.011 -.010	T* Dia. ±.005	V Thread UNEF-2A (Plated)
8	.473	.022	.594	.812	.120	.4375-28
10	.590	.027	.719	.938	.120	.5625-24
12	.750	.027	.812	1.031	.120	.6875-24
14	.875	.027	.906	1.125	.120	.8125-20
16	1.000	.027	.969	1.219	.120	.9375-20
18	1.125	.027	1.062	1.312	.120	1.0625-18
20	1.250	.054	1.156	1.438	.120	1.1875-18
22	1.375	.054	1.250	1.562	.120	1.3125-18
24	1.500	.054	1.375	1.688	.147	1.4375-18

All dimensions for reference only.



# MIL-DTL-38999 Series II

## MS27508 Box Mount Receptacle, Rear Mount

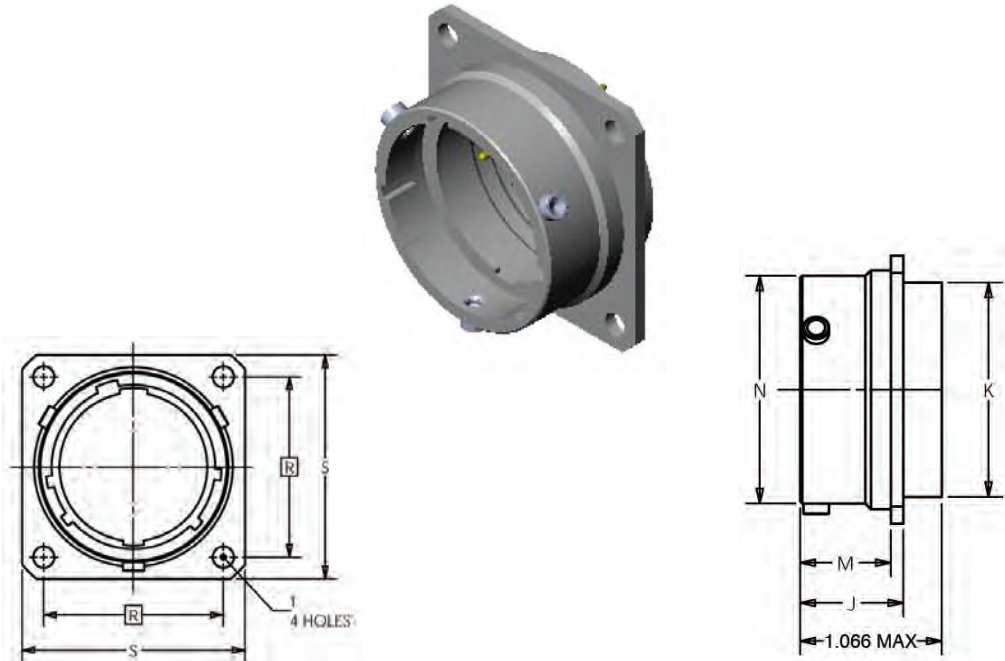

Shell Size	K Dia. +.000 -.007	N Dia. +.001 -.005	P Max. Panel Thickness	R (TP)	S +.011 -.010	T Dia. ±.005	W Dia. +.001 -.005	M +.000 -.005	J +.006 -.000
8	.438	.473	.147	.594	.812	.120	.516	.322	.505
10	.562	.590	.152	.719	.938	.120	.633	.322	.505
12	.688	.750	.152	.812	1.031	.120	.802	.322	.505
14	.812	.875	.152	.906	1.125	.120	.927	.322	.505
16	.938	1.000	.152	.969	1.219	.120	1.052	.322	.505
18	1.062	1.125	.152	1.062	1.312	.120	1.177	.322	.505
20	1.188	1.250	.179	1.156	1.438	.120	1.302	.322	.505
22	1.312	1.375	.179	1.250	1.562	.120	1.427	.322	.505
24	1.438	1.500	.179	1.375	1.688	.147	1.552	.322	.505

All dimensions for reference only.

# MIL-DTL-38999 Series II

## MS27474 Jam Nut Receptacle

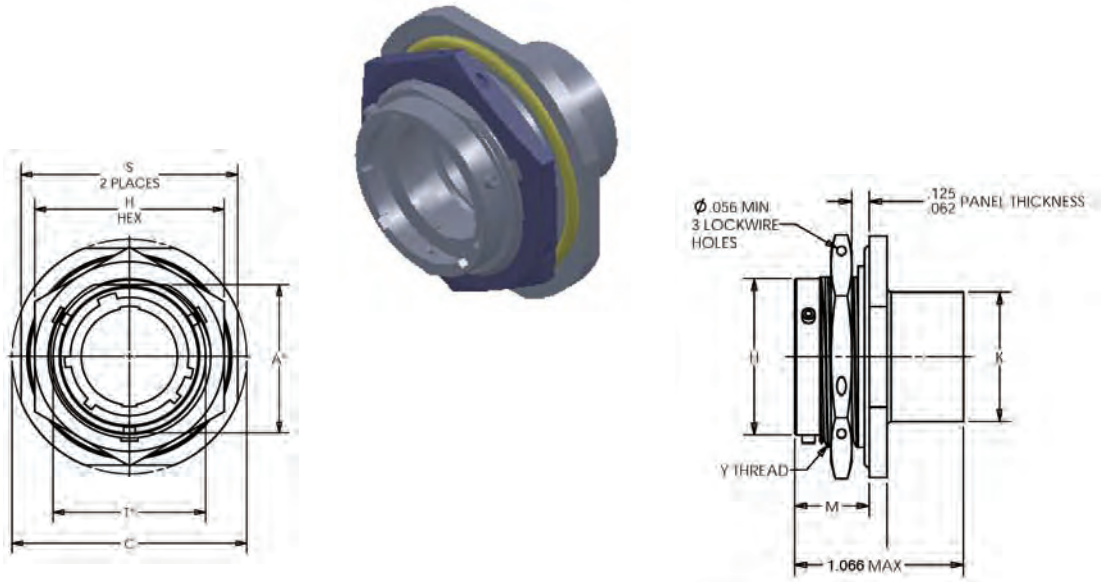

Shell Size	A* Flat +.000 -.010	C Dia. +.011 -.010	H Hex +.017 -.016	M ±.005	N Dia. +.001 -.005	R Thread (Plated) Class -2A	S ±.010	T* Dia. +.010 -.000	V Thread UNEF-2A (Plated)
8	.830	1.375	1.062	.438	.473	.8750-20UNEF	1.250	.884	.4375-28
10	.955	1.500	1.188	.438	.590	1.0000-20UNEF	1.375	1.007	.5625-24
12	1.084	1.625	1.312	.438	.750	1.1250-18UNEF	1.500	1.134	.6875-24
14	1.208	1.750	1.438	.438	.875	1.2500-18UNEF	1.625	1.259	.8125-20
16	1.333	1.938	1.562	.438	1.000	1.3750-18UNEF	1.781	1.384	.9375-20
18	1.459	2.016	1.688	.438	1.125	1.5000-18UNEF	1.890	1.507	1.0625-18
20	1.576	2.141	1.812	.464	1.250	1.6250-18UNEF	2.016	1.634	1.1875-18
22	1.701	2.265	2.000	.464	1.375	1.7500-18UNS	2.140	1.759	1.3125-18
24	1.826	2.390	2.125	.464	1.500	1.8750-16UN	2.265	1.884	1.4375-18

All dimensions for reference only.

# MIL-DTL-38999 Series III

## D38999/20 Box Mount Receptacle

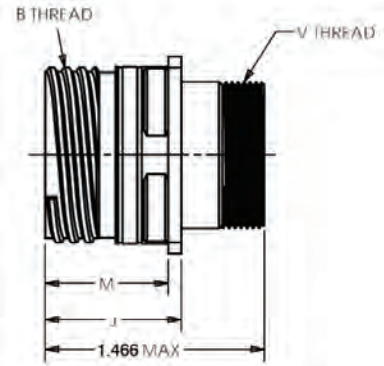
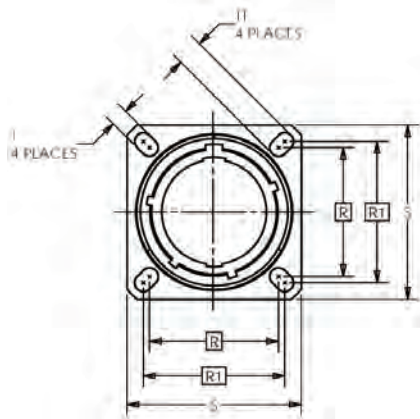

Shell Size	B Thread Class 2A 0.1P-0.3L-TS (Plated)	M +.000 -.005	J +.006 -.000	R <sub>1</sub> TP	R <sub>2</sub> TP	S Max	T +.008 -.006	V Thread Metric (Plated)	TT +.008 -.006
9	.6250	.820	.905	.719	.594	.948	.128	M12X1-6g0.100R	.216
11	.7500	.820	.905	.812	.719	1.043	.128	M15X1-6g0.100R	.194
13	.8750	.820	.905	.906	.812	1.137	.128	M18X1-6g0.100R	.194
15	1.0000	.820	.905	.969	.906	1.232	.128	M22X1-6g0.100R	.173
17	1.1875	.820	.905	1.062	.969	1.323	.128	M25X1-6g0.100R	.194
19	1.2500	.820	.905	1.156	1.062	1.449	.128	M28X1-6g0.100R	.194
21	1.3750	.790	.905	1.250	1.156	1.575	.128	M31X1-6g0.100R	.194
23	1.5000	.790	.905	1.375	1.250	1.701	.154	M34X1-6g0.100R	.242
25	1.6250	.790	.905	1.500	1.375	1.823	.154	M37X1-6g0.100R	.242

All dimensions for reference only.



# MIL-DTL-38999 Series III

## D38999/24 Jam Nut Receptacle

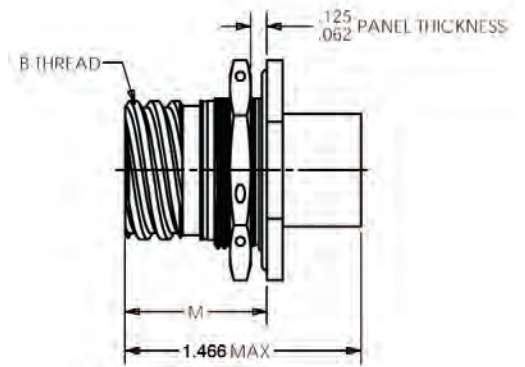
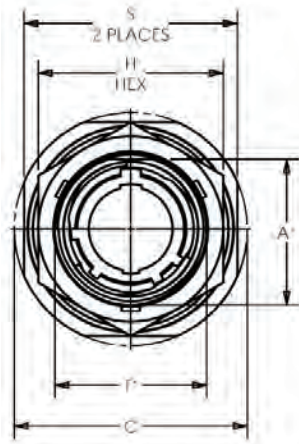

Shell Size	A Dia* Max	B Thread Class 2A 0.1P-0.3L-TS (Plated)	H Hex +.017 -.016	R Thread Metric (Plated)	S ±0.10	T*Dia +.010 -.000	V Thread Metric (Plated)	M +.011 -.010	Z* Flat +.000 -.010
9	1.199	.6250	.875	M17X1-6g0.100R	1.062	.697	M12X1-6g0.100R	.871	.669
11	1.386	.7500	1.000	M20X1-6g0.100R	1.250	.822	M15X1-6g0.100R	.871	.769
13	1.511	.8750	1.188	M25X1-6g0.100R	1.375	1.007	M18X1-6g0.100R	.878	.955
15	1.636	1.0000	1.312	M28X1-6g0.100R	1.500	1.134	M22X1-6g0.100R	.878	1.084
17	1.761	1.1875	1.438	M32X1-6g0.100R	1.625	1.259	M25X1-6g0.100R	.878	1.208
19	1.949	1.2500	1.562	M35X1-6g0.100R	1.812	1.384	M28X1-6g0.100R	.878	1.333
21	2.073	1.3750	1.688	M38X1-6g0.100R	1.938	1.507	M31X1-6g0.100R	.878	1.459
23	2.199	1.5000	1.812	M41X1-6g0.100R	2.062	1.634	M34X1-6g0.100R	.878	1.575
25	2.323	1.6250	2.000	M44X1-6g0.100R	2.188	1.759	M37X1-6g0.100R	.878	1.709

All dimensions for reference only.

# MIL-DTL-38999 Series I, II, III Insert Arrangements

Shell Size & Insert Arrg.								
Service Rating	9-35	9-98	11-2	11-4	11-5	11-35	11-98	11-99
Number of Contacts	M	I	I	I	I	M	I	I
Contact Size	6	3	2	4	5	13	6	7
	22D	20	16	20	20	22D	20	20

Shell Size & Insert Arrg.						
Service Rating	13-8	13-35	13-98	15-4	15-5	15-15
Number of Contacts	I	M	I	I	II	I
Contact Size	8	22	10	4	5	14 1
	20	22D	20	12	16	20 16

Shell Size & Insert Arrg.					
Service Rating	15-18	15-35	15-37	15-97	17-2
Number of Contacts	I	M	M	I	M
Contact Size	18	37	37	8 4	38 1
	20	22D	22M	20 16	22D 8 Twinax

Shell Size & Insert Arrg.				
Service Rating	17-6	17-8	17-25	17-26
Number of Contacts	I	II	M	I
Contact Size	6	8	22 2	26
	12	16	22D 8 Coax	20

# MIL-DTL-38999 Series I, II, III Insert Arrangements

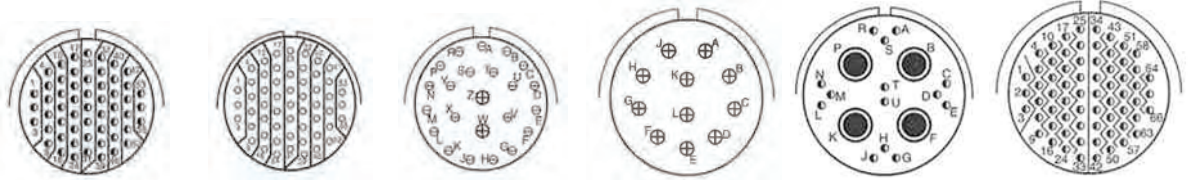

Shell Size &  
Insert Arrg.  
Service Rating  
Number of Contacts  
Contact Size

17-35	17-55	17-99	19-11	19-18	19-35
M	M	I	II	M	M
55	55	21 2	11	14 4	66
22D	22M	20 16	16	22D 8 Twinax	22D

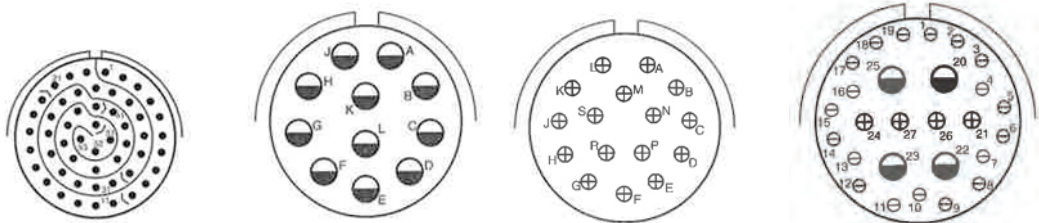

Shell Size &  
Insert Arrg.  
Service Rating  
Number of Contacts  
Contact Size

19-53	21-11	21-16	21-29
M	I	II	I
53	11	16	19 4 4
22	12	16	20 16 12

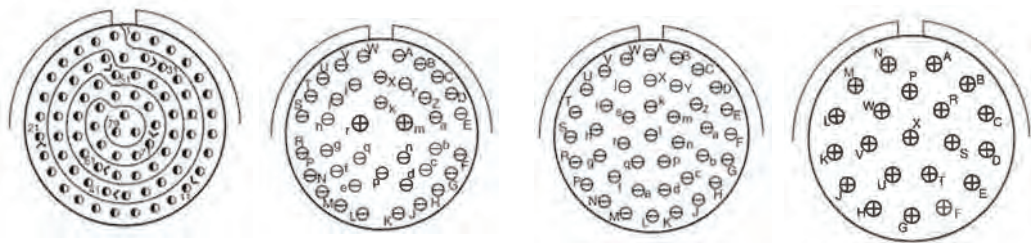

Shell Size &  
Insert Arrg.  
Service Rating  
Number of Contacts  
Contact Size

21-35	21-39	21-41	23-21
M	I	I	II
79	37 2	41	21
22D	20 16	20	16



# MIL-DTL-38999 Series I, II, III Insert Arrangements

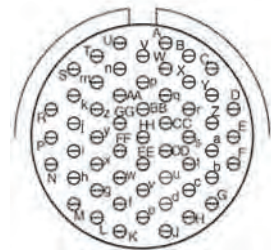
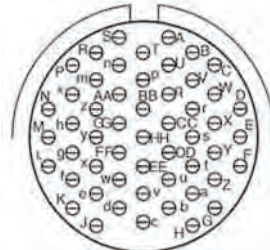
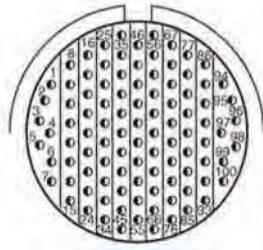

Shell Size &  
Insert Arrg.  
Service Rating  
Number of Contacts  
Contact Size

23-35  
M  
100  
22D

23-53  
I  
53  
20

23-55  
I  
55  
20

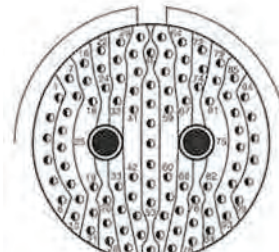
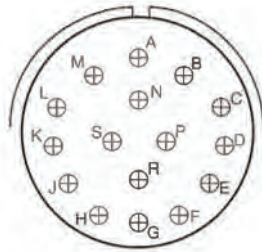

Shell Size &  
Insert Arrg.  
Service Rating  
Number of Contacts  
Contact Size

23-97  
II  
16  
16

25-7  
M  
97 2  
22D 8 Twinax

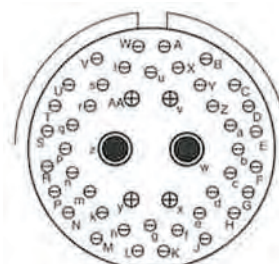
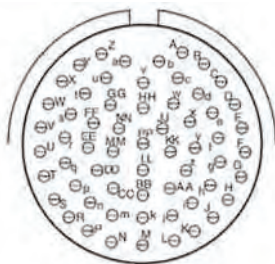

Shell Size &  
Insert Arrg.  
Service Rating  
Number of Contacts  
Contact Size

25-61  
I  
61  
20

25-90  
I  
40 4 2  
20 16 8 Twinax

# MIL-DTL-38999 Series I, II, III Insert Arrangements

Shell Size &  
Insert Arrg.  
Service Rating  
Number of Contacts  
Contact Size

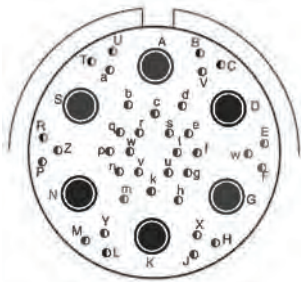

25-17  
M  
36 6  
22D 8 Twinax

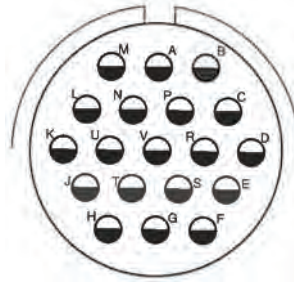

25-19  
I  
19  
12

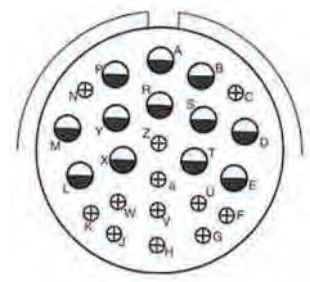

25-24  
I  
12 12  
16 12

Shell Size &  
Insert Arrg.  
Service Rating  
Number of Contacts  
Contact Size

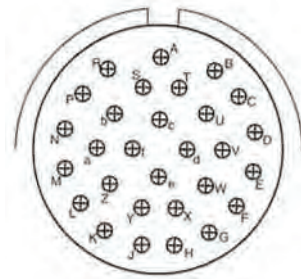

25-29  
I  
29  
16

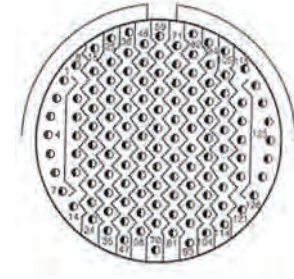

25-35  
M  
128  
22D

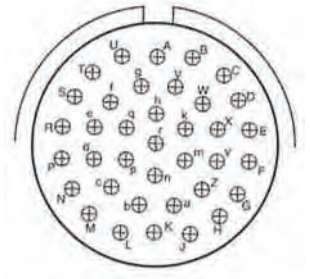

25-37  
I  
37  
16

Shell Size &  
Insert Arrg.  
Service Rating  
Number of Contacts  
Contact Size

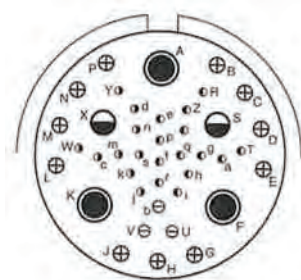

25-41  
N/Inst.  
22 3 11 2 3  
22D 20 16 12 Coax 8 Twinax

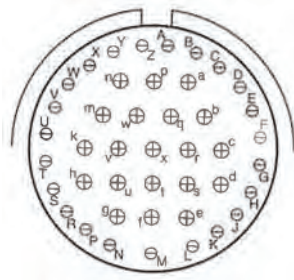

25-43  
I  
23 20  
20 16

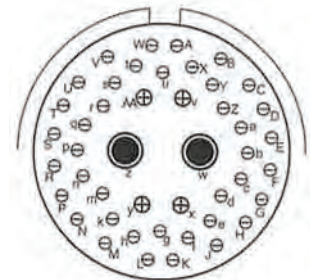

25-46  
I  
40 4 2  
20 16 8 Coax

# MIL-C-26482 Series II Filter Connectors

## MIL-C-26482 Series II Filter Connectors

MIL-C-26482 Series II filter connectors from Amphenol Canada are designed and manufactured to meet or exceed the requirements of the Military Specification. All ACC filter connectors are intermateable and interchangeable with standard non-filtered MIL-C-26482 Series II connectors unless otherwise specified.

### Materials and Finishes

Shell – Aluminum alloy

Insulator – High grade plastic

Contacts – Copper alloy, gold plate

Grommet and seal – Silicone based elastomer

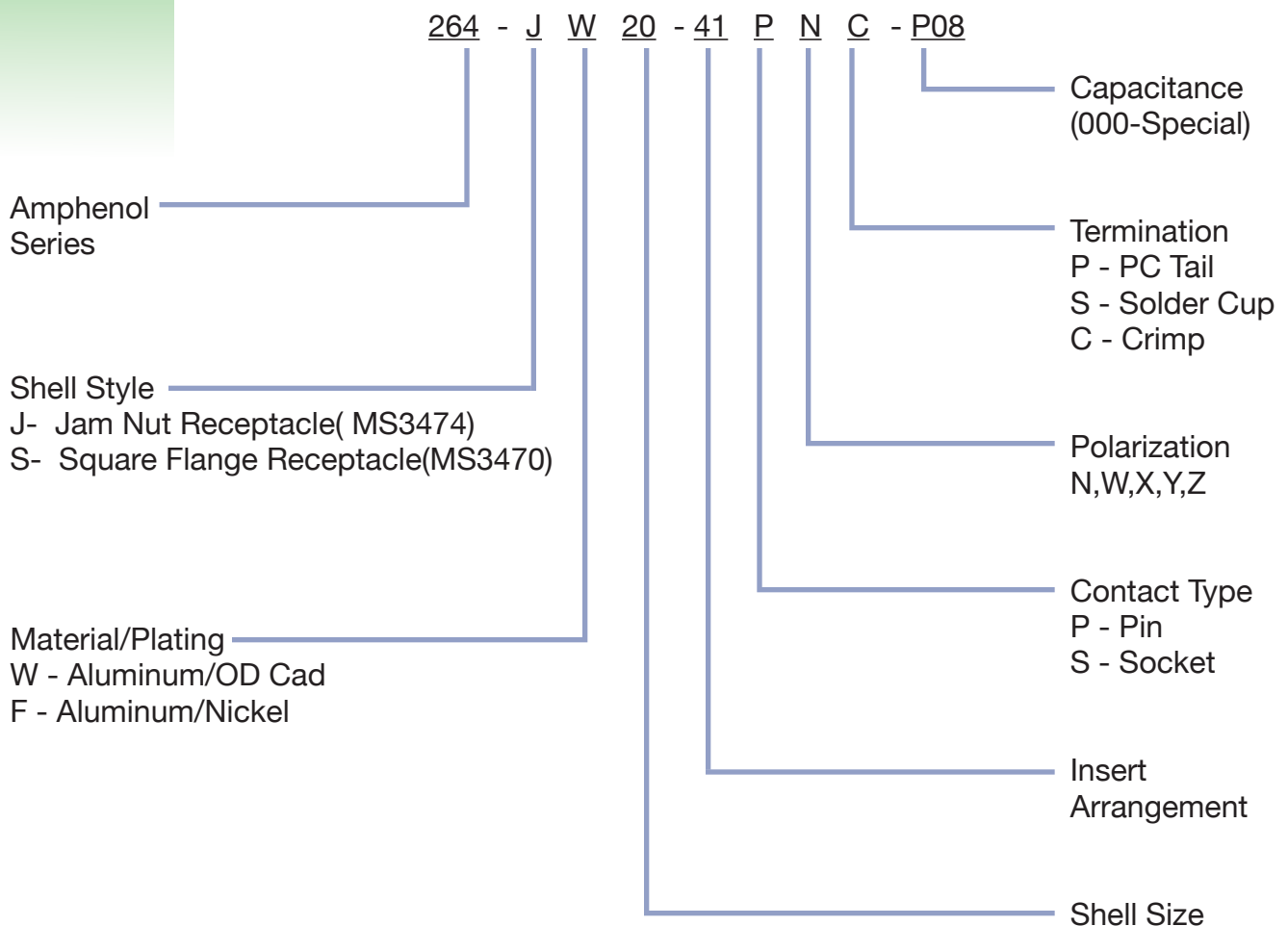



# MIL-DTL-26482 Series II

## MS3470 Box Mount Receptacle

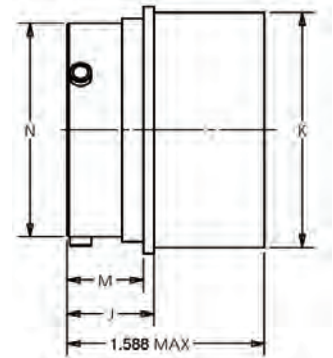
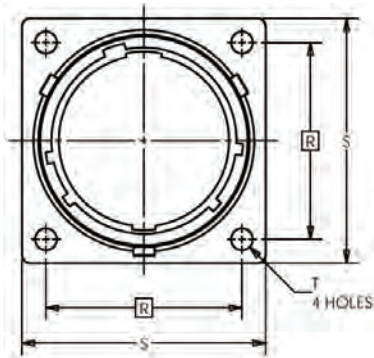

Shell Size	J +.021 -.010	K Dia. +.011 -.000	M +.010 -.000	N Dia. +.001 -.005	P* Max.	R (TP)	S +.011 -.010	T Dia. ±.005
8	.493	.438	.431	.473	.087	.594	.812	.120
10	.493	.562	.431	.590	.087	.719	.938	.120
12	.493	.688	.431	.750	.087	.812	1.031	.120
14	.493	.812	.431	.875	.087	.906	1.125	.120
16	.493	.938	.431	1.000	.087	.969	1.219	.120
18	.493	1.062	.431	1.125	.087	1.062	1.312	.120
20	.650	1.188	.556	1.250	.212	1.156	1.438	.120
22	.650	1.312	.556	1.375	.212	1.250	1.562	.120
24	.683	1.438	.589	1.500	.212	1.375	1.688	.147

All dimensions for reference only.

# MIL-DTL-26482 Series II



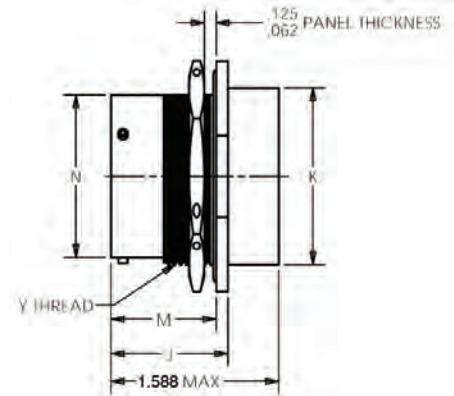
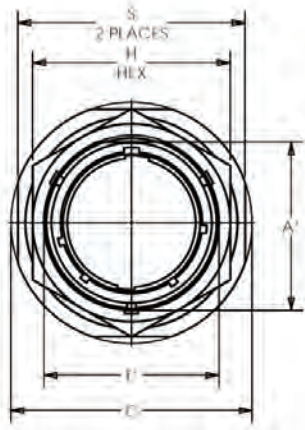





## MS3474 Jam Nut Receptacle

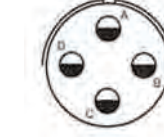

Shell Size	A* Flat +.000 -.010	C Dia. +.011 -.010	H Hex +.017 -.016	J +.006 -.005	K Dia. +.011 -.000	M ±.005	N Dia. +.001 -.005	S ±.010	T* Dia. +.010 -.000	Y Thread UNEF-2A (Plated)
8	.542	1.062	.750	.821	.438	.696	.473	.938	.572	.5625-24
10	.669	1.188	.875	.821	.562	.696	.590	1.062	.697	.6875-24
12	.830	1.375	1.062	.821	.688	.696	.750	1.250	.884	.8750-20
14	.955	1.500	1.188	.821	.812	.696	.875	1.375	1.009	1.0000-20
16	1.084	1.625	1.312	.821	.938	.696	1.000	1.500	1.134	1.1250-18
18	1.208	1.750	1.438	.821	1.062	.696	1.125	1.625	1.259	1.2500-18
20	1.333	1.938	1.562	1.040	1.188	.884	1.250	1.812	1.384	1.3750-18
22	1.459	2.062	1.688	1.040	1.312	.884	1.375	1.938	1.509	1.5000-18
24	1.575	2.188	1.812	1.073	1.438	.917	1.500	2.062	1.634	1.6250-18

All dimensions for reference only.

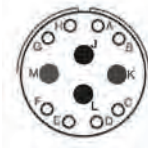
# MIL-DTL-26482 Series II Insert Arrangements

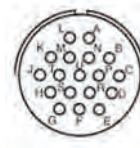
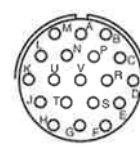
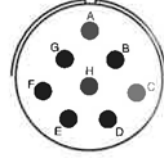
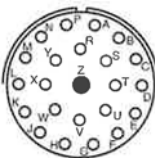
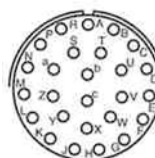
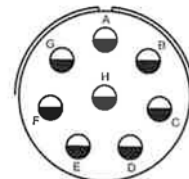
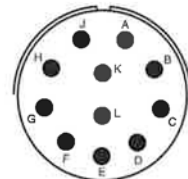
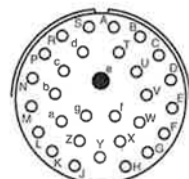
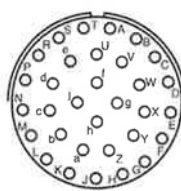
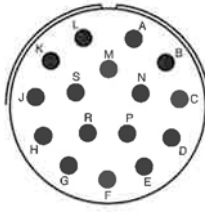
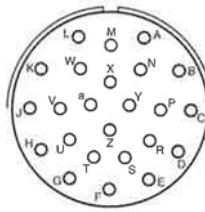
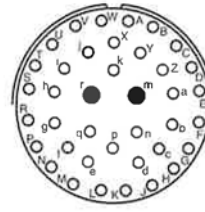
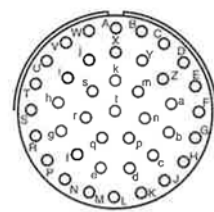
							
Insert Arrangement	8-98	10-06	12-03	12-08	12-10	14-04	14-05
Service Rating	I	I	II	I	I	I	II
Number of Contacts	3	6	3	8	10	4	5
Contact Size	20	20	16	20	20	12	16
							
Insert Arrangement	14-09	14-12	14-15	14-18	14-19	16-08	
Service Rating	I	I	I	I	I	II	
Number of Contacts	5	4	8	1	18	19	8
Contact Size	20	12	20	16	20	20	16
							
Insert Arrangement	16-23	16-26	18-08	18-11	18-30		
Service Rating	I	I	I	II	I		
Number of Contacts	22	1	26	8	11	29	1
Contact Size	20	16	20	12	16	20	16
							
Insert Arrangement	18-32	20-16	20-24	20-39	20-41		
Service Rating	I	II	I	I	I		
Number of Contacts	32	16	24	37	2	41	
Contact Size	20	16	20	20	16	20	

# MIL-DTL-26482 Series II Insert Arrangements

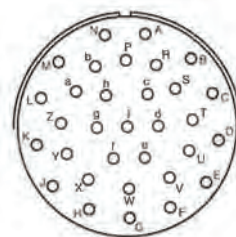
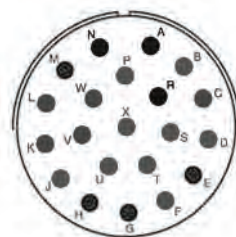
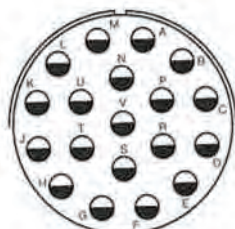
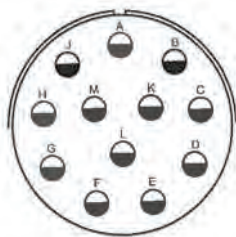

Insert Arrangement  
Service Rating  
Number of Contacts  
Contact Size

22-12  
I  
12  
12

22-19  
I  
19  
12

22-21  
II  
21  
16

22-32  
I  
32  
20

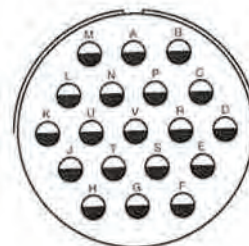
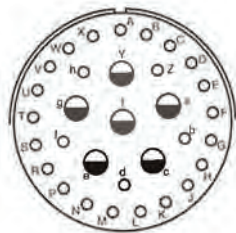
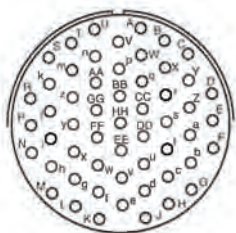
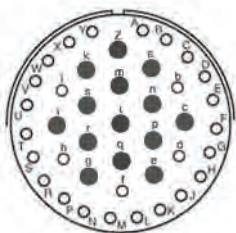

Insert Arrangement  
Service Rating  
Number of Contacts  
Contact Size

22-41  
I  
27 14  
20 16

22-55  
I  
55  
20

22-95  
I  
26 6  
20 12

24-19  
II  
19  
12

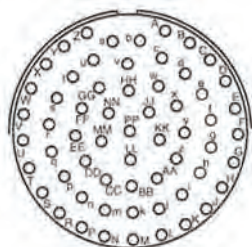
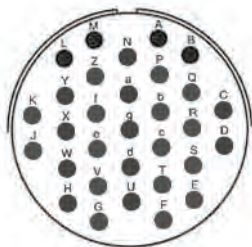

Insert Arrangement  
Service Rating  
Number of Contacts  
Contact Size

24-31  
I  
31  
16

24-61  
I  
61  
20



# MIL-C-55116 Filter Audio Connectors

164 F Series Filter audio connectors meet or exceed all MIL-C-55116 requirements, including mating durability, environmental sealing, and thermal cycling. They mate to standard plugs, with screw machined contacts, passivated stainless steel shell, and high grade thermoplastic inserts, and the patented Amphenol solderless stress-isolation design, resulting in a shorter, lighter connector with superior thermal and physical shock capabilities.

## CUSTOMIZATION OPTIONS:

- Pin numbers and sizes
- Grounded pins
- Filtering topology
- Lightning protection
- Ultra-high sealing capabilities
- Alternate cable/wire/board termination styles
- Alternate materials and plating
- Value-added construction and harnessing

164F - 1836S - A02

# of contacts  
5 or 6

**Contact Termination**  
B = PCB tail  
S = solder cup  
H = wire lead  
(customer-specified length & configuration)

Consult factory for custom options.

### Deviation/Filtering Code

01 = 2,000 pF - 3,000 pF C  
02 = 8,000 pF - 16,000 pF C  
03 = 24,000 pF min. Pi  
04 = 72,000 pF min. Pi  
(xx = custom designs) and Pi Filters

### Shell Style

A = medium body (L=1.131")  
B = medium body, reverse mount  
C = short body (L=0.910")  
(-01 filter only)  
D = short body, reverse mount  
E = long body (L = 1.405")  
F = long body, reverse mount

0.150"

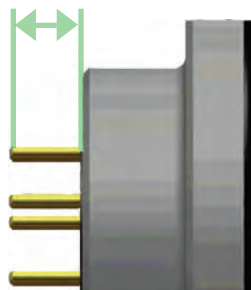

164F-1836B-xxx  
PCB tail termination

0.220"

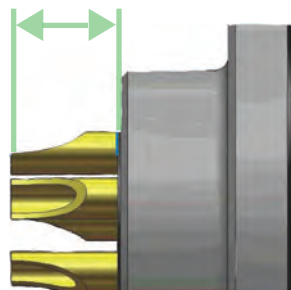

164F-1836S-xxx  
Solder cup termination

defined by customer application

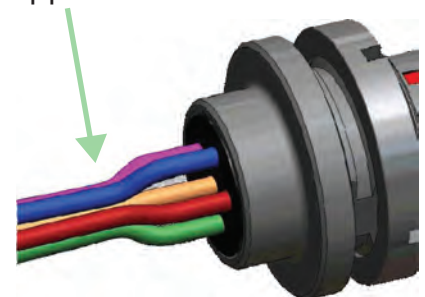

164F-1836H-xxx  
Wire lead /  
harnessed termination

# MIL-C-55116 Filter Audio Connectors

- Interface and environmental performance of MIL-C-55116/9, -/10
- Operating temperature range -55°C to +125°C
- DWV = 500 VDC
- IR = 1,000 MΩ (sea level)
- Typical working voltage = 60 VDC
- Current rating = 0.5 A
- Spring loaded contacts with minimum mating durability of 3000 cycles
- Fully sealed to water ingress up to 20m immersion depth

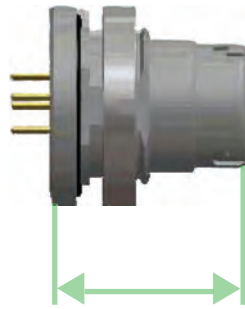

L = 0.910"

164F-1836B-3xx  
Short body

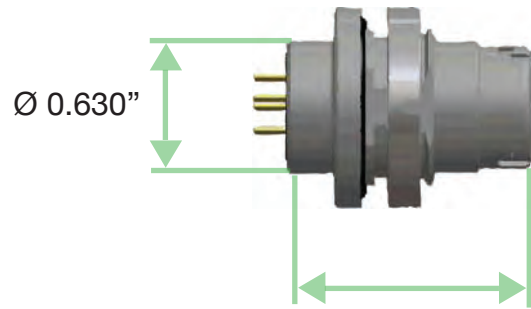

Ø 0.630"

L = 1.131"

164F-1836B-1xx  
Medium body

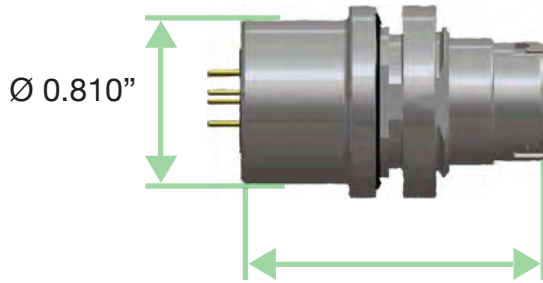

Ø 0.810"

L = 1.405"

164F-1836B-5xx  
Long body

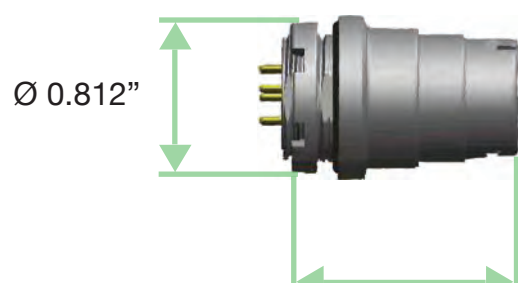

Ø 0.812"

L = 1.131"

164F-1836B-2xx  
Medium body,  
Reverse mount



## Termination Modules

A termination module is a removable extension of the connector which is recommended for use with ARINC connectors which have transient suppression devices or which are difficult to attach to a flex or pcb. The engagement side of the termination module is designed to mate to the rear of the connector and the termination end is designed to attach to the PCB or wire harness (PC tails, soldercups, wire-wrap or crimp). Proper engagement of the connector and termination module is guaranteed by guide posts in the connector and front or rear activated jack screws. Sealing is accomplished with a rubber interfacial gasket.

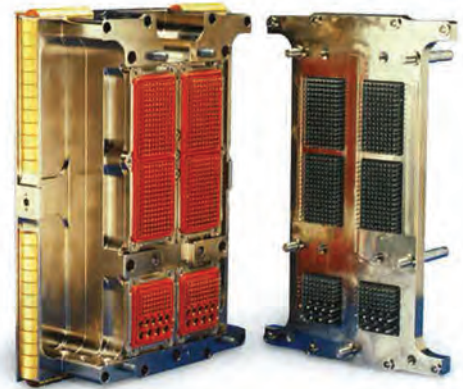

Connectors designed to engage to a termination module are designed with one-piece front removable socket contacts to minimize the number of interconnects.

The use of a termination module provides several advantages:

- simplifies the assembly process by soldering to the lighter weight termination module rather than to the connector itself
- facilitates repair and rework procedures due to easy installation and removal from the motherboard

### Features:

- Guide posts and front or rear activated jack screws
- Easy installation and removal from motherboard
- One piece front removable socket contact in filter connector
- Rubber interfacial seal

### Benefits:

- Guarantees proper installation
- Facilitates repair and rework
- Eliminates exposure of filter connector to soldering and cleaning processes
- Protects filter connector from environment
- Allows for easy repair of damaged socket contacts
- Minimizes total number of interconnects



\*Consult factory for a termination module suitable to your needs.

# Filter Terminal Blocks

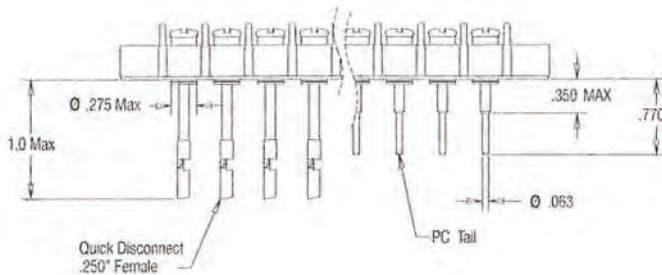
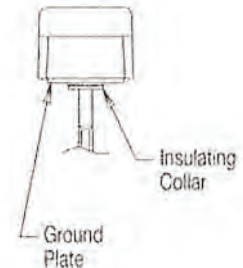
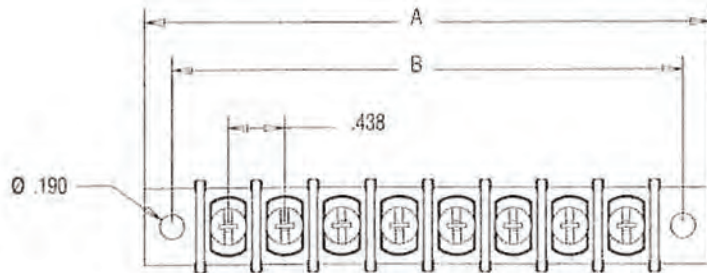

# Terminals	Dim 'A' ±.020	Dim 'B'
2	1.730	1.312
3	2.170	1.750
4	2.610	2.187
5	3.050	2.625
6	3.480	3.062
7	3.920	3.500
8	4.360	3.937
9	4.800	4.375
10	5.230	4.812
11	5.670	5.250
12	6.110	5.687

FXL - 06 C252 10 0 - 000

NUMBER OF TERMINALS  
02 - 12

CAPACITANCE CODE  
C101 = 100pF (+100%/-0%)  
C252 = 2500pF  
C503 = 5000pF

(Last digit of code is the number of zeros after first 2 digits)

DEVIATION  
000 = Standard Part  
other deviations are required

MOUNTING STYLE  
0 = Thru Hole  
9 = Special

TERMINATION STYLE  
03 = Solder Cup  
04 = P.C. Tail  
08 = Press Fit  
09 = Male Quick Disconnect (.250 Blade)  
10 = Female Quick Disconnect (.250 Blade)  
11 = Wire Harness



# FXH Bolt-In Filtered Header

This header is tougher than the average filtered array. Ceramic filter elements are isolated from mating and handling loads, which means your assembly works the first time, every time.

Economical, non-metallic designs are also available in the same footprint.

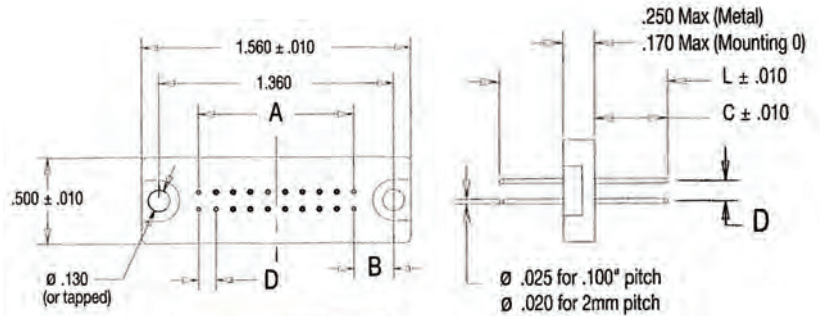

Mounting Style 0

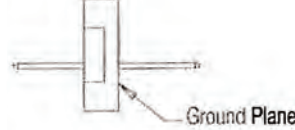
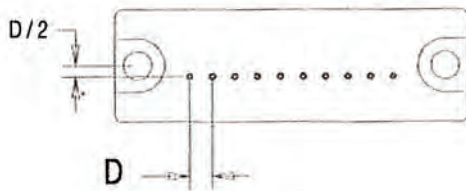
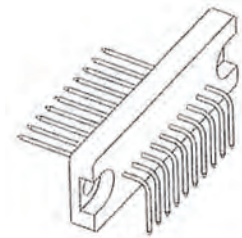

Terminal Styles	Dim 'L'	Dim 'C'
1,4	0.825	0.360
2, 5	1.100	0.550
3	Consult factory	

Terminals per row	Terminal Styles 1, 2 & 3			Terminal Styles 3, 4 & 5 [mm]		
	'A'	'B'	'D'	'A'	'B'	'D'
4	0.300	0.530	0.100	6.0	14.27	2.0
5	0.400	0.430		8.0	12.27	
6	0.500	0.430		10.0	12.27	
7	0.600	0.330		12.0	10.27	
8	0.700	0.330		14.0	10.27	
9	0.800	0.230		16.0	8.27	
10	0.900	0.230		18.0	8.27	
11	---	---		20.0	6.27	
12	---	---		22.0	6.27	

FXH - 20 C252 D 2 0 - 000

NUMBER OF TERMINALS  
04 - 24

CAPACITANCE CODE  
C101 = 100pF (+100%/ -0%)  
C252 = 2500pF  
C402 = 4000pF  
(Last digit of code is the number of zeros after first 2 digits)

Rows of Contacts  
S = Single Row  
D = Double Row

DEVIATION  
000 = Standard Part  
other deviations are required

MOUNTING STYLE  
0 = Thru Hole  
1 = Metal Body thru Hole  
2 = Metal Body 4-40 UNC  
3 = Metal Body M3 x 0.5  
9 = Snap-In Header

TERMINATION STYLE  
1 = Straight, 0 .025, 0.825 Long  
2 = Straight, 0 .025, 1.100 Long  
3 = Right Angle bend, built to suit  
4 = Straight, 2mm, 0 .20, .825 Long  
5 = Straight, 2mm, 0 .020, 1.100 Long

# FXH Snap-In Filtered Header

Protect your Board-to-Board signals against radiated and conducted EMI.

This header snaps into place without assembly tools and saves real estate.

## SPECIFICATIONS

### PRODUCT FEATURES:

- Compact, connector-like assembly
- Stress isolated filters
- .100" or 2mm pitch

### MATERIALS AND PLATINGS:

- Insulators
- Grounding spring
- Contacts
- UL94V-0 thermoplastic
- Copper alloy, nickel plated
- Copper alloy, gold over nickel

### ELECTRICAL RATINGS:

- DWV 500 Vdc
- Insulation Resistance 5 G q at 200 vdc
- Capacitance + 100/-0%
- Current Rating 3 A
- Temperature - 55°C / 125°C

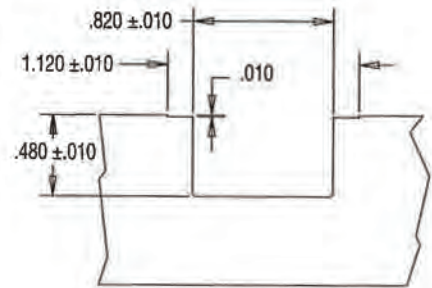
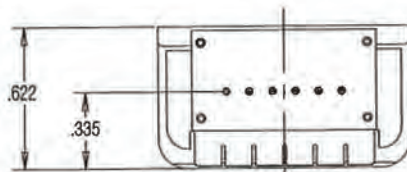
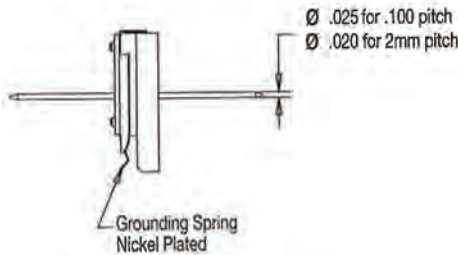
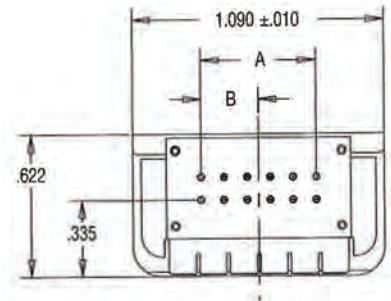
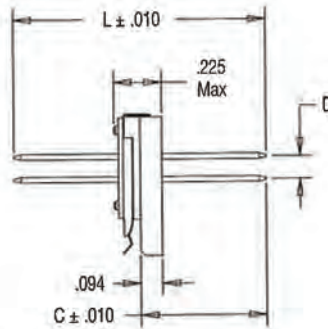

Panel Cutout  
.057 ± .002 Thickness

Terminals per row	Terminal Styles 1, 2 & 3			Terminal Styles 3, 4 & 5 [mm]		
	'A'	'B'	'D'	'A'	'B'	'D'
3	0.200	0.150	0.100	4.0	2.0	2.0
4	0.300	0.150		6.0	4.0	
5	0.400	0.250		8.0	4.0	
6	0.500	0.250		10.0	6.0	
7	---	---		12.0	6.0	

Terminal Styles	Dim 'L'	Dim 'C'
1,4	0.825	0.400
2,5	1.100	0.550
3	Consult factory	

# Quadrax Connectors and Contacts

## DESCRIPTION

- Quadrax contacts offer the best copper technology solution for high speed data requirements.
- Consists of 4 size 24 inner contacts forming two matched impedance differential pairs within a size 8 outer contact.

## PRODUCT FEATURES

- Designed to the requirements of Arinc 600, supplement 14.
- Available in crimp and PCB tail versions
- Crimp version Outer contact designed to use standard size 8 crimp tools, M22520/5-01 and/or M22520/5-45
- Crimp version Inner contacts designed to use standard size 24 crimp tools M22520/2-01
- Compatible with various quadrax cables (see table 1)

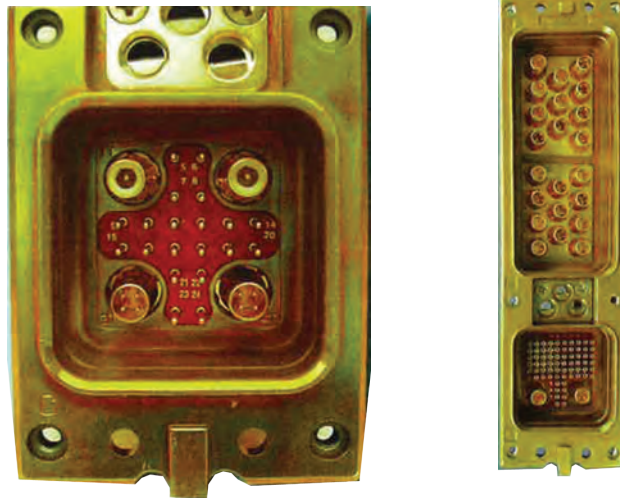

## APPLICATIONS

- Ethernet 100Base -T-100 ohm Fiber channel-150 ohm and IEEE 1394B fire-wire I 10 ohm applications
- Commercial Avionics Systems
- In-Flight Entertainment Systems
- Military Avionics Systems

## TYPICAL ELECTRICAL PERFORMANCE

- Bandwidth: Up to 3 Gigahertz
- Data Rate: Exceeding 2 Gbits/sec
- Voltage Rating: 500 Vrms max. @ sea level
- Dielectric Withstanding Voltage:
  - 1000 VAC rms between all inner contacts at sea level
  - 500 VAC rms between inner and outer contacts @ sea level.



# Quadrax Contact

## Part Numbering Information

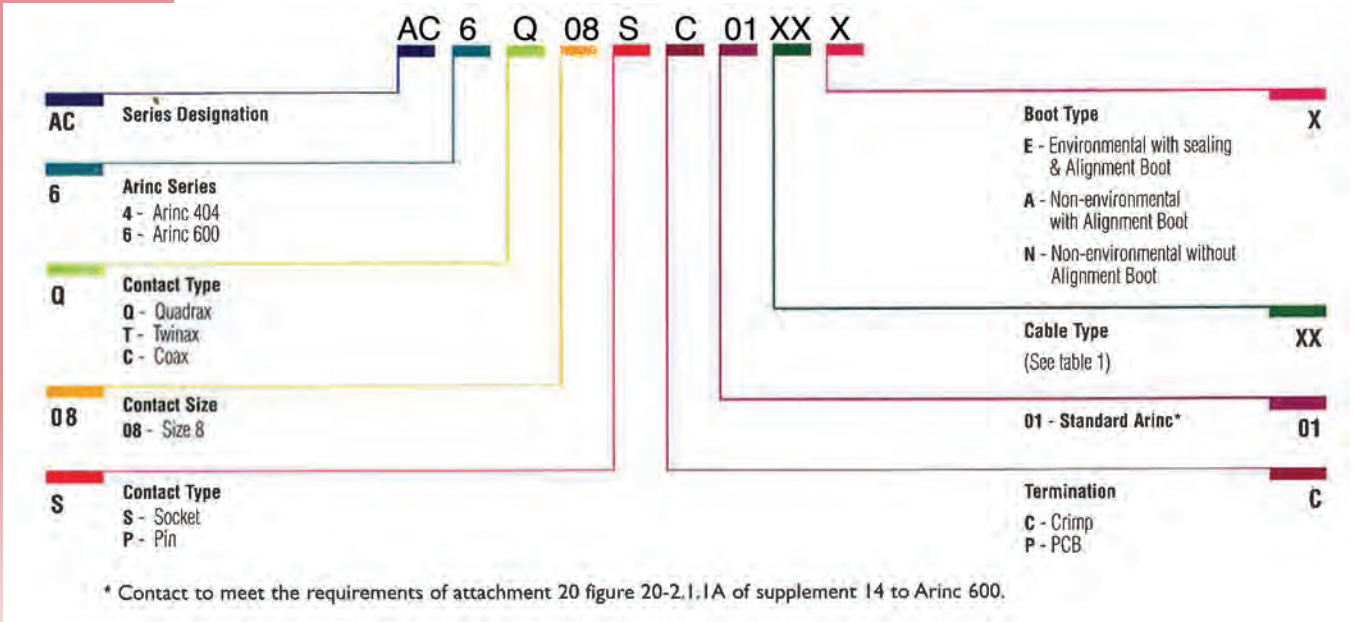
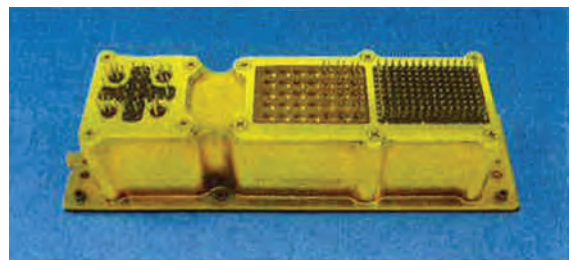
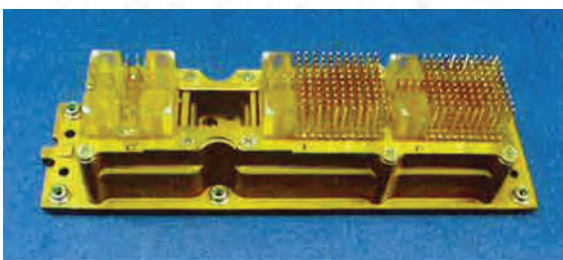

Table 1 - Quadrax Contact Part Numbers

Socket Part Number	Pin Part Number	Cable Type	Impedance
AC-6Q08SC01-01N	AC-6Q08PC01-01N*	DRAKA FILICA F4703-3 & F4704-4	100 ohm
AC-6Q08SC01-01A	AC-6Q08PC01-01A		
AC-6Q08SC01-01E	AC-6Q08PC01-01E		
AC-6Q08SC01-02N	AC-6Q08PC01-02N*	TENSOLITE NF24Q100	100 ohm
AC-6Q08SC01-02A	AC-6Q08PC01-02A		
AC-6Q08SC01-02E	AC-6Q08PC01-02E		
AC-6Q08SC01-03N	AC-6Q08PC01-03N*	TENSOLITE 26473102006X-4(LD) or GORE RCN8328	150 ohm
AC-6Q08SC01-03A	AC-6Q08PC01-03A		
AC-6Q08SC01-03E	AC-6Q08PC01-03E		
---	AC-6Q08PP01-XX	N/A	100 ohm

\* Quadrax Pin Contact P/N's AC-6Q08PC01-XXN do not conform to Supplement 14 to Arinc 600. Supplement 14 to Arinc 600 requires that Quadrax Pin Contacts be supplied with an alignment boot.





# Quadrax Connector Insert Arrangements

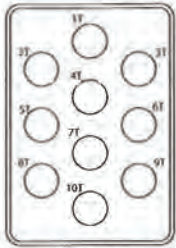

Insert Q10  
10#8 Quadrax  
Contacts

Q10

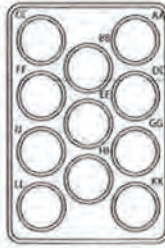

Insert Q11  
11#8 Quadrax  
Contacts

Q11

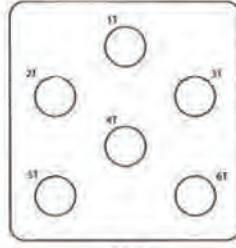

Insert Q6  
6#8 Quadrax  
Contacts

Q6

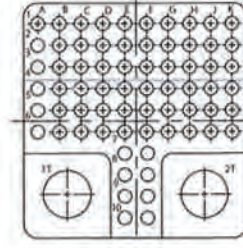

Insert 68Q2  
68#22 Contacts  
2#8 Quadrax  
Contacts

68Q2

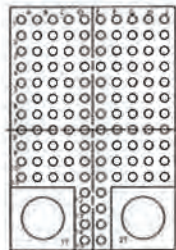

Insert 118Q2  
118#22 Contacts  
2#8 Quadrax  
Contacts

118Q2

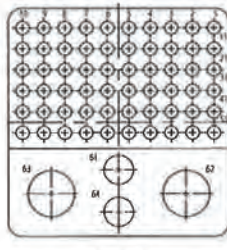

Insert 62Q2  
60#22 Contacts  
2#16 Contacts  
2#8 Quadrax  
Contacts

62Q2

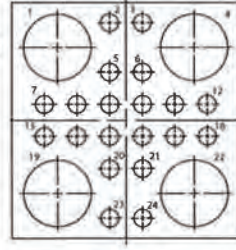

Insert 20Q4  
20#16 Contacts  
4#8 Quadrax  
Contacts

20Q4

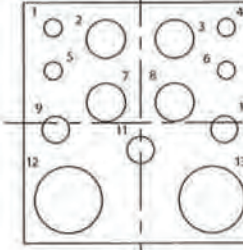

Insert 11Q2  
4#12 Contacts  
3#16 Contacts  
4#20 Contacts  
2#8 Quadrax  
Contacts

11Q2

- Grounding continuity per Arinc 600 specification available on all size 8 cavities.
- Contact Factory for other insert arrangements

## CRIMP PIN Quadrax Contact

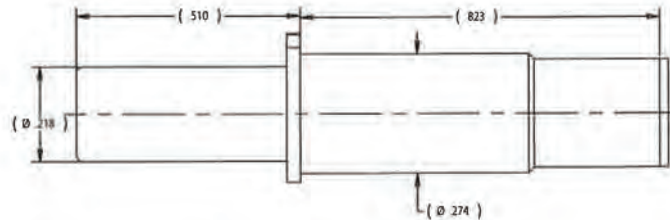
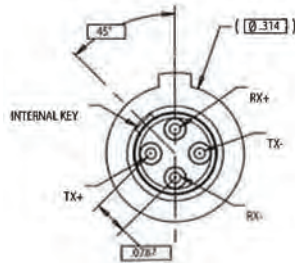

## CRIMP SOCKET Quadrax Contact

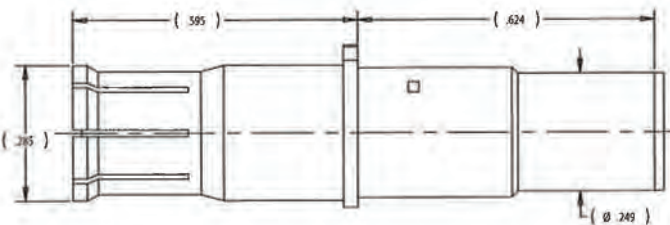
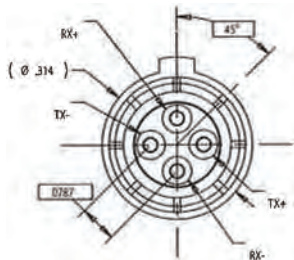

## PCB PIN Quadrax Contact

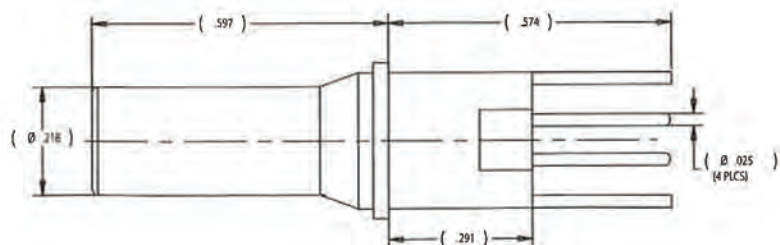

## Additional Product

### Quadrax

Amphenol Canada can put high speed ethernet differential quadrax contacts into any of our connectors. These offer 100 ohm differential impedance in 2 twinax for transmit and receive 1 gigabit ethernet signals. The quadrax can be cable termination or PC tail versions and the intergrated quadrax technology of Amphenol Canada reduces the cost of these specialty contacts.



### SD308 Connectors ( Sealed)

The SD308 series of D-Subminiature connectors is designed specifically for applications where advanced sealing is required. These connectors have unique sealed bodies and blind inserts to meet stringent immersions requirements. Along with those sealing techniques a special flange to incorporate a sealing gasket can provide additional sealing from connector to chassis.





**Amphenol® ARINC 600**  
Rack and Panel Connectors

SL-379-1



Amphenol® Canada Corporation

**RECTANGULAR**

INFINITE POSSIBILITIES.



Amphenol®  
Rectangular and Filtered Products

**Amphenol® ARINC 404**  
Rack and Panel Connectors

SL-379-3



Amphenol® Canada Corporation

**R27**



CONNECTING SYSTEMS  
OF THE FUTURE

Amphenol  
FILTERED AND RECTANGULAR CONNECTORS

# Amphenol Canada

5950 14th Avenue, Markham,  
Ontario, Canada, L3S 4M4

The shape of things to come.

**R39**

Amphenol's rectangular connector soars to meet higher expectations.

- Rectangular space savings
- Low profile
- High density 127 position inserts or mixed inserts with power, RF or low-voltage available
- Blind mate
- Rugged
- Uses same contacts as standard 38999

Dynamically engineered for a changing world.

Amphenol Aerospace Products

Amphenol®

**FX**



Send a clear signal  
FX Filtered Connectors

Amphenol®  
Rectangular and Filtered Products

**MMA**



Amphenol  
FILTERED AND RECTANGULAR CONNECTORS

Amphenol®  
Canada



ENGINEERED SOLUTIONS. DESIGNED TO FIT

**MICRO** CONNECTOR PRODUCTS

0997 (1.27 mm) PITCH

Specifications subject to change without notice  
Designed by: Carrie Baynes Designs

CB1112